

2019 Catalog

Since 1946

WITTEK



EAGLE ONE



Golf Supply Specialists



800-869-1800
wittekgolf.com

To Our Valued Customers & Those We Have Not Yet Done Business With –

We are extremely excited that you have received our **brand new 2019 catalog**. This past year we have been working to completely redesign, reorganize and improve both our catalog and our products so that they are all better fit for you and your facility. Inside you'll find everything from range and course equipment, maintenance supplies, pro shop and mini golf supplies and several brand new, comprehensive furniture collections.

Since 1946, Wittek Golf has been known as the leading range and golf course supplier in the industry, and we have yet to slow down since. Inside this catalog you will find new products, improved products, and everything you need to keep your facility running smoothly. Even better than that, everything inside these pages can be **ordered online, 24/7 on our online store**.

In 2016, we acquired Delta Golf, to provide you with the highest quality and best priced rental clubs on the market. **In 2017, we acquired Eagle One**, which gave us the ability and capacity to create unmatched recycled plastic furnishings for your course, range and outdoor areas. At our Los Angeles location, we manufacture flags, signage and everything recycled plastic, meaning you can customize almost anything to your liking. In our Chicago location, we manufacture our ball washers, pickers, dispensers, flagsticks and more. Having two manufacturing and distribution locations means that if you order something before 1 PM and it's in stock at one of our locations, **it ships out the same day**.

As always, let us know how we can serve you and your business. We are always looking for new ways to improve and grow our business, and it starts with hearing how we can help you improve yours. Thank you for your business in the previous years and the opportunity to serve you. We look forward to continuing to grow our business with you in the years to come.

Sincerely,
Gene and Tim Proban

Hours: 7:00am – 7:00pm CST



800.869.1800



847.412.9591



info@wittekgolf.com



www.wittekgolf.com

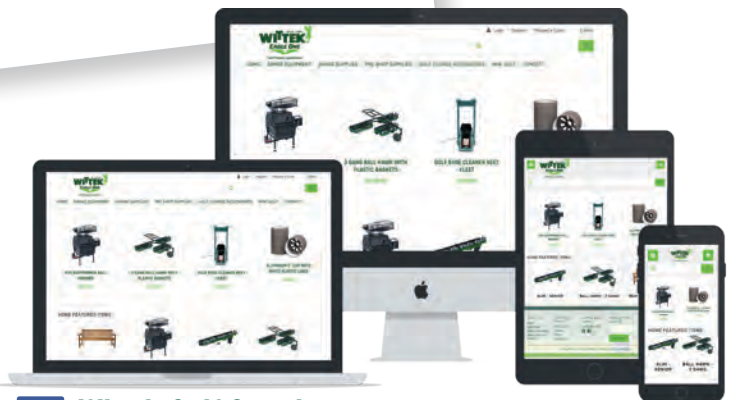

Wittek Golf Supply



@WittekGolf



@Wittekgolfsupply



RANGE EQUIPMENT

RANGE SUPPLIES

GOLF COURSE ACCESSORIES

IRRIGATION & MAINTENANCE

PRO SHOP ACCESSORIES

MINI GOLF

2019 TABLE OF CONTENTS

RANGE EQUIPMENT



Ball Pickers 8-15
 - A-Frames 16
 - Cart Adapters 16
 - Conversion Kits 16
 - Picker Baskets 17

Ball Dispensers 21-22
 - Payment Acceptors 22-23

Ball Washers 18-20
 - Soap 19

Cart Protectors 16

Replacement Parts 8-17
 - Full Parts List 134-137

RANGE SUPPLIES



Balls 29
Ball Crates 31
Ball Popper 33
Ball Stackers 38
Bag Racks & Stands 34-35
Bag Shags 32
Bag Shag Tube 33
Club Cleaners 36-37
FlagD 38

Hand Pickers 33
Mats 24-26
Netting 43
Pail Organizer 31
Practice Nets & Cages 44-45
Practice Stick 33
Radios 28
Range Markings 46-49
Range Bags 30

Range Pails & Baskets 31
Range Targets 47
Range Trays 27
Range Woods 29
Rubber Tees 27, 29
Sign Holders 40-41
Starter Clocks 42
Tee Dividers 39
Yardage Markings 40-41

GOLF COURSE ACCESSORIES



Adirondack Series 98
Benches 95
Bunker Rakes 84 -85
Cape Cod Collection 97
Coolers 92
Cups 59
Cup Dispenser 92
Custom Course Collection 101
Divot Bottle Storage 88
Divot Mix Storage 89
Flags 50-55
Flag Sticks 56-58

Heritage Collection 99
Huntington Collection 96 Outdoor
Signs 66-72
Paper Cups 92
Picnic Tables and more 100
Podiums 94
Practice Green Markers 63-65
Putting Green Accessories 60
Putting Green Flags 61-62
Putting Green Flagsticks 64
Reflectors 57
Shoe Cleaning Station 76-77

Signs 66-72
Spike Cleaners 77
Stakes & Rope 78-83
Tee Consoles 102-103
Tee & Information Signs 68-71
Tee Markers 73-75
Towels 103
Tournament Accessories 91
Trash Containers 90-91
Water Stations 92-93
Yardage Marker Systems 67

IRRIGATION & MAINTENANCE



Hand Tools 108
Hole Cutters 106-107
Hoses 113
Irrigation Attachments 113
Maintenance Accessories 104

Marking Paint 105
Marking Supplies 105
Nozzles 113
Pitchers 112
Rakes 111

Soil Surfactants Applicators 112
Suction Pumps 112
The KLAW 109
Tournament Accessories 91
Trimmers & Gages 110-111

PRO SHOP ACCESSORIES



Ball Markers 120
Custom Bag Tags 121
Divot Tools 120
Golf Cart Accessories 116

Golf Cart Towels 116
Golf Grips 124-125
Pencils 118
Rental Clubs 122-123

Repair Accessories 122
Replacement Cleats 121
Tees 119

MINI GOLF



Balls 130-131
Ball Vendor 129
Grips 128

Putters 126-127
Putter Holders 128
Scorecards 129

Signs 133
Tee Off Mats 132
Turf 132

Order online 24/7 @ www.wittekgolf.com

THE WALNUT COLLECTION

Our new Walnut Collection of recycled plastic products is here to redefine the outdoor furniture industry. Made from the same durable and maintenance free material, the Walnut Collection has the look of real wood without the upkeep of it. Made here in the U.S.A, the Walnut Collection is the perfect blend of durability and craftsmanship, that fits in any course's budget.

RANGE EQUIPMENT

RANGE SUPPLIES

GOLF COURSE ACCESSORIES

IRRIGATION & MAINTENANCE

PRO SHOP ACCESSORIES

MINI GOLF



#405201WN
See page 94



#T189
See page 91



#T188WN
See page 91



#T305WN
See page 89

#405311WN
See page 89



#54345WN
See page 35



#P059AWN
See page 39



800-869-1800

NEW FOR 2019

#T071WN
See page 94



#405466WN
See page 93



#405481WN
See page 92



#T245WN
See page 99



#C428WN
See page 98

#77856WN
See page 36



Check your order history @ www.wittekgolf.com

NEW PRODUCTS IN 2019

RANGE EQUIPMENT

RANGE SUPPLIES

GOLF COURSE ACCESSORIES

IRRIGATION & MAINTENANCE

PRO SHOP ACCESSORIES

MINI GOLF

▶ FLAGD

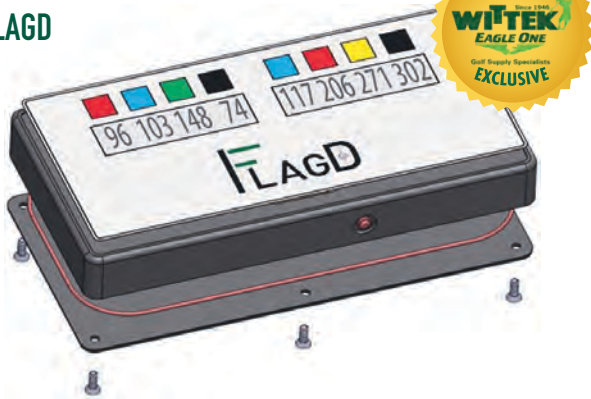

#500001 - Plain Unit



- #405690BLK - Black
- #405690BRN - Brown
- #405690GRN - Green
- #405690DRT - Driftwood
- #405690WN - Walnut



See page #28

▶ VINYL GUARD



VINYL GUARD® golf

For 3/4" Tapered Flagstick
250' Roll

For 1/2" Tapered Flagstick
250' Roll

For 1" Rake Handle
250' Roll

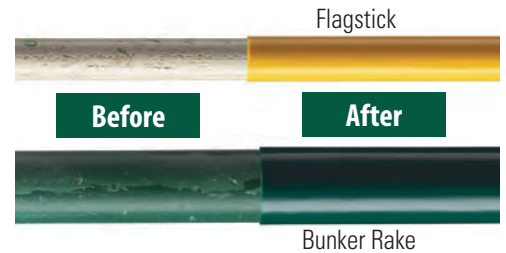

See page #57(Pre-Shrunk Flagsticks)
See page #86 (All VinylGuard products)

▶ CART TOPPERS



Finally a tournament solution that actually works! Make sure your guests know which cart is theirs, and that you get them out on the course on time. These cart toppers make it easy to make tournaments run smoothly!
Available in Black, Blue, Green, Hot Pink, Orange, Purple, Turquoise, Yellow, Red, Lime, White, Tan.

- #94405 - Set of 18
- #94404 - Set of 36

See page #117

WITTEK TWIST



The Twist is the latest addition to our already award-winning washer lineup. The Wittek Twist is made in the U.S.A of heavy gauge galvanized steel, a powerful drive motor and a self-contained water tank. The compact design is the perfect choice for low to medium volume golf courses and driving ranges.

#73489 See page #20

Windy City Divot mix Container

- #4053GN - Green
- #4053BN - Brown
- #4053BK - Black

See page #89



Windy City Club Cleaner

- #778GN - Green
- #778BN - Brown
- #778BK - Black

See page #36



Windy City Trash Container

- #4054BK - Black
- #4054BN - Brown
- #4054GN - Green

See page #91



WINDY CITY

HITTING TARGET

These fantastic targets are great for short game practice. Made using a sturdy Polybutylene frame with UV protected nylon netting and the bases are weighted for added stability.

- 79174 - Tee Target - 4' Diameter
- #79178-25 25 Yard Target Net Yardage Plate
- #79178-50 50 Yard Target Net Yardage Plate
- #79178-75 75 Yard Target Net Yardage Plate
- #79178-100 100 Yard Target Net Yardage Plate

#P075RT - Reflective Tape Strip (3" W x 11.5" L)

See page #47

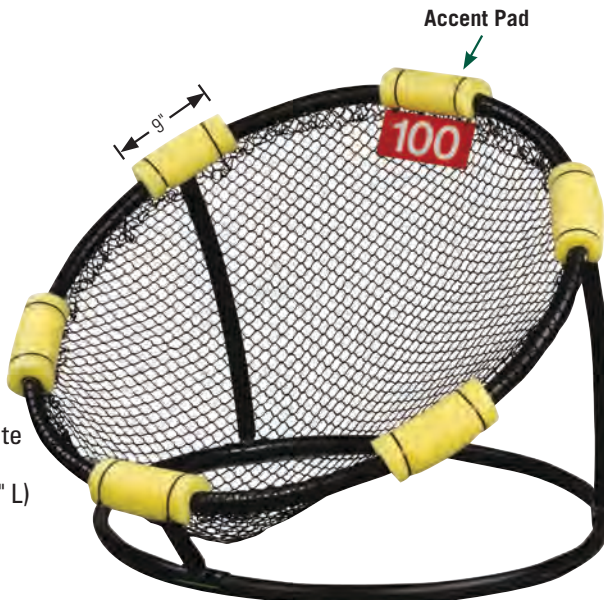

Now with a reflective tape and yardage plate option!



Chat with specialists @ www.wittekgolf.com

EAGLE LITE PICKER

*The picker of choice at the
2018 U.S. Open Championship!*



REVERSIBLE

Now with a built-in front wheel.

LIGHT MEETS MIGHT

The **lightest** ball retriever in the golf market. The Eagle Lite puts less pressure on the cart and allows for **faster picking time**. The newest edition to the Pro Line Series. ONLY 240 pounds. It is 9' wide. Comes complete with push bar and mounting bracket.

Holds 1,800 balls.

#71423P - Black Discs

#71423PW - White Discs

See Page 12 for more information.

▶ PLASTIC PICKER BASKETS



300 Balls Per Basket

Our picker baskets are made of a tough polyethylene that offers high strength and impact resistance. Lighter and more durable than wire baskets.

#71912

The only stackable plastic picker baskets in the industry, designed for easy storage and shipping!

Benefits

- Less Pressure on Cart
- Stronger Nylon Discs
- Faster Picking Time
- Bearingless Picker
- Lightest Ball Retriever in the market
- Reversible

THE WITTEK ELITE SERIES DISPENSER

One-ball-at-a-time vending!

- **ACCOUNTABILITY.** Our ball dispensers provide features and benefits far beyond other models. Account management, sales tracking, and cash accountability are just a few of the operational tools to help you evaluate, analyze, and control driving range ball sales.
- **FLEXIBILITY.** Utilizing our **one-ball-at-a-time vending**, you have the ability to deliver any number of balls in up to three bucket sizes. This means you can effectively boost sales by configuring a bucket pricing structure best suited to your facility.
- **CONVENIENCE.** By offering multiple payment options and locating the ball dispenser near the tee line your customer may conveniently make additional purchases. For the operator, this means increased sales revenue and a reduction in operating costs.

- Customized payment options: PIN, e-key, cash, and credit card.
- 10,000 ball capacity.
- Vends eleven balls per second.
- Front or rear load machines available.
- Token style supplies one bucket size reliably time after time after time 63" H x 36" L x 42" W (494 lbs.).

▶ VENDING COMBINATIONS

- #74760 - Token Only
- #74761 - Bill Acceptor Only
- #74763 - Token/Bill Acceptor
- #74759 - Dispenser Only
- Upgrade** - 220 Volt



Reorder easily @ www.wittekgolf.com

RANGE ROVER BALL PICKER

Combining Versatility with Maneuverability

Front section, front caster fork, and wheel are all in one for the ultimate inflexibility, strength, maneuverability, and unsurpassed reliability. The Wittek Range Rover provides the most control and the highest rate of picking performance.

- Swiftest, most maneuverable picker on the market. Backs out of the toughest spots with ease.
- Powder coated finish provides ultimate protection and rust resistance.
- Assembles in just 15 minutes.

REVERSIBLE

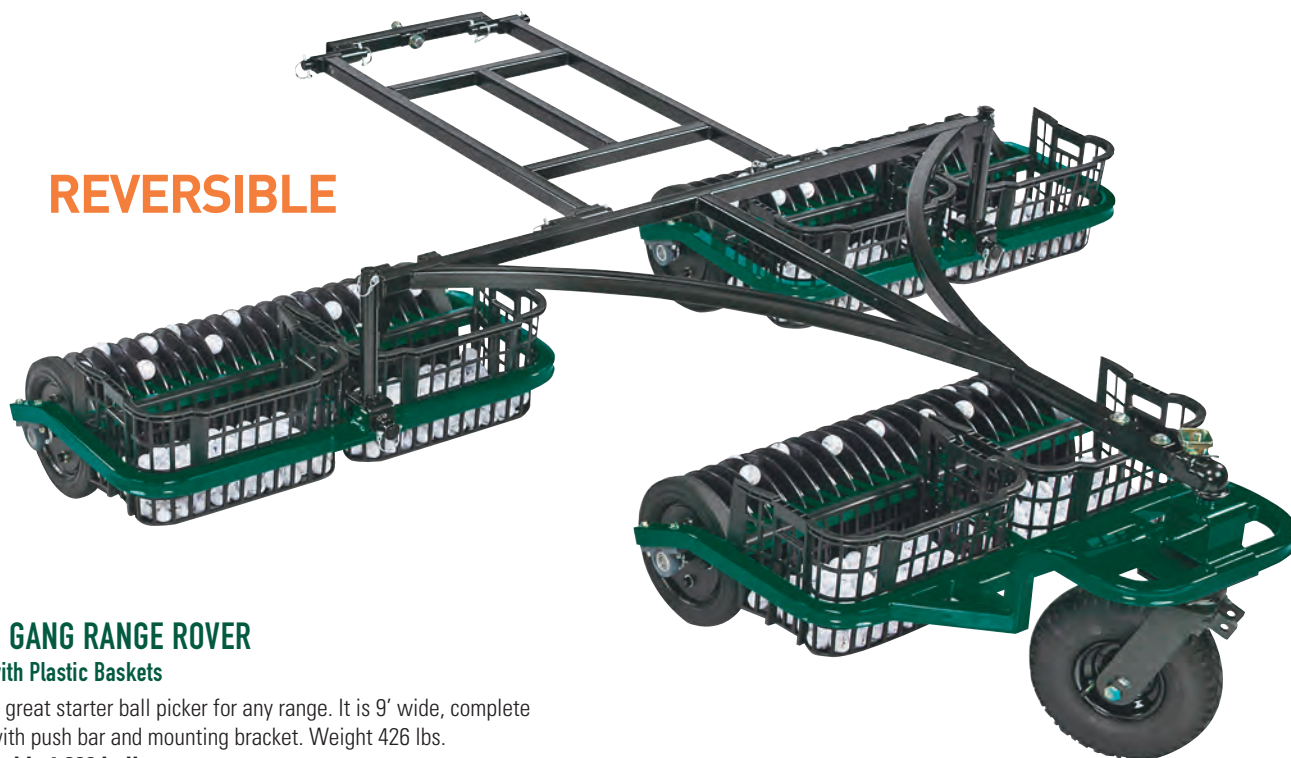

▶ 3 GANG RANGE ROVER with Plastic Baskets

A great starter ball picker for any range. It is 9' wide, complete with push bar and mounting bracket. Weight 426 lbs.

Holds 1,800 balls.

#71413P - Black Discs

#71413PW - White Discs



ADDITIONAL FEATURES



NEWLY DESIGNED COMPOSITE WHITE AND BLACK DISCS

These lightweight, durable discs, maximize productivity on the range. Drums come standard with black discs. Upgrade to white for soft cover balls.



ADVANCED TURNING SYSTEM

Newly engineered tires on each end of the drum, combined with pillow block bearings, provide added reinforcement that greatly maximizes strength and maneuverability.



ALL-IN-ONE SWIVEL CASTER FORK AND WHEEL

Provides more control, flexibility and maneuvering ability than any other picker on the market.

STACKABLE



Maneuverability

The Range Rover can be backed out of the tightest spots. The gangs will not get tangled, so there is no need to exit the vehicle while range is in use.

Durability

Grease fittings have been placed on all critical wear points to extend the life of your picker.

▶ **PLASTIC PICKER BASKETS**

300 Balls Per Basket

Our picker baskets are made of a tough polyethylene that offers high strength and impact resistance. Lighter and more durable than wire baskets. 13"L x 19½"W x 10½"H (2 lbs.)

The only stackable plastic picker baskets in the industry, designed for easy storage and shipping!

#71912

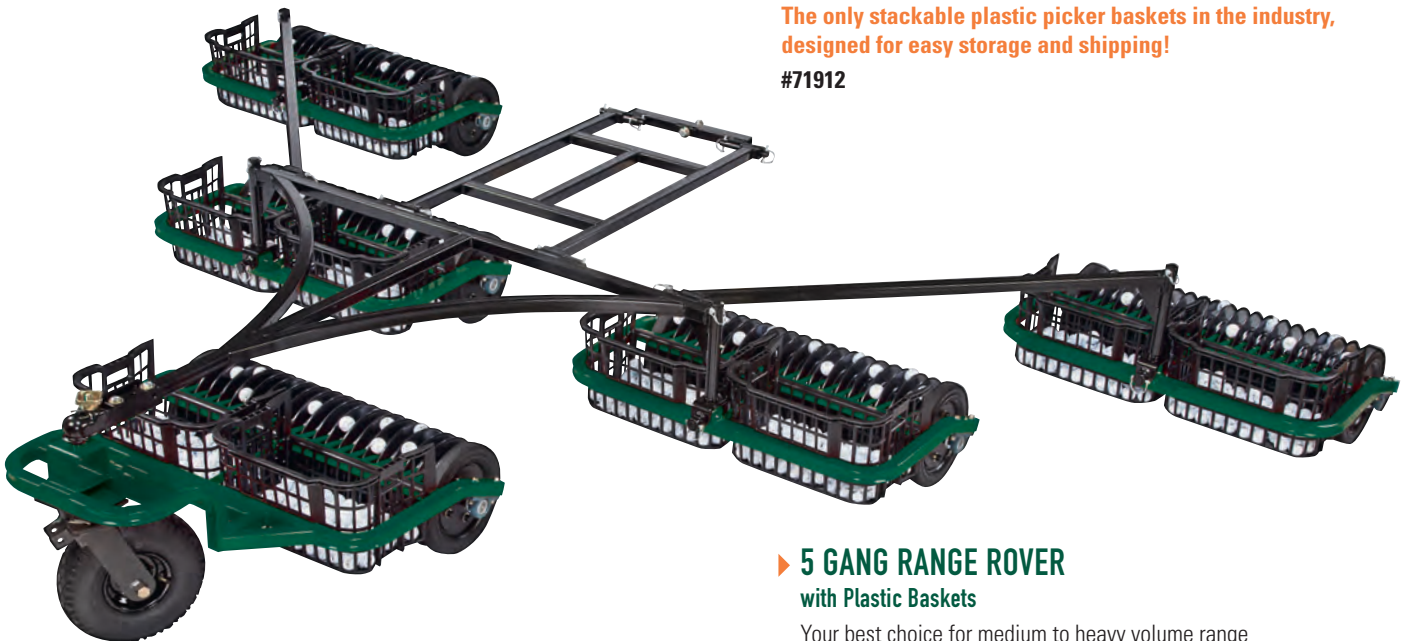

▶ **5 GANG RANGE ROVER**

with Plastic Baskets

Your best choice for medium to heavy volume range operations. It is 15' wide. Complete with push bar and mounting bracket. Weight 635 lbs. **Holds 3,000 balls.**

#71415P - Black Discs

#71415PW - White Discs



EXTRA HEAVY DUTY POST ASSEMBLIES

The only solid steel post assemblies in the industry provide greater strength and performance.

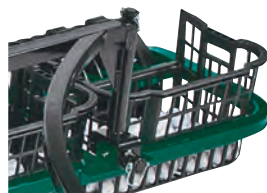

ANOTHER WITTEK EXCLUSIVE

1½" square tubing - largest in the industry! A powder coat finish results in high strength and long lasting performance and protection.

ACCESSORIES & PARTS

See Pg 104 for Complete Diagram and parts list.

#71920 - Replacement Black Drum Section

#71920W - Replacement White Drum Section

#71801 - Pillow Block Bearings

#71989 - Front Wheel/Tire/Axle/Bearings

#71936 - Swivel Caster Fork

#71919 - Tie Rods (including hardware)

#71932 - Disc Only - Black

#71932W - Disc Only - White

Use your terms @ www.wittekgolf.com

BALL HAWK PICKER

The Ball Retriever Preferred By Most Driving Ranges

The Ball Hawk Series ball pickers contour to any terrain featuring a newly engineer advance turning systems.

The picker of choice at the 2018 PGA Championship!

- Powder coated finish provides ultimate protection and rust resistance.
- Assembles in just 15 minutes.

**BUILT NOT TO LAST
BUT TO OUTLAST!**



▶ 3 GANG BALL HAWK with Plastic Baskets

It is 9' wide and holds 1,800 balls, but can easily increase to a five gang that holds **3,000 balls**. Comes complete with push bar and mounting bracket. Weight 395 lbs.

#71403P - Black Discs

#71403PW - White Discs



ADDITIONAL FEATURES



NEWLY DESIGNED COMPOSITE WHITE AND BLACK DISCS

These lightweight, durable discs, maximize productivity on the range. Drums come standard with black discs. Upgrade to white for soft cover balls.

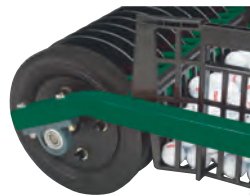

ADVANCED TURNING SYSTEM

Newly engineered tires on each end of the drum, combined with pillow block bearings, provide added reinforcement that greatly maximize strength and maneuverability.



SPRING LOADED FORK ASSEMBLY

Provides more control, flexibility and maneuvering ability than any other picker on the market.



STACKABLE



Durability

Sealed bearings on the drum sections and front wheel reduce maintenance.

▶ **PLASTIC PICKER BASKETS**

300 Balls Per Basket

Our picker baskets are made of a tough polyethylene that offers high strength and impact resistance. Lighter and more durable than wire baskets. 13"L x 19½"W x 10½"H (2 lbs.)

The only stackable plastic picker baskets in the industry, designed for easy storage and shipping!

#71912

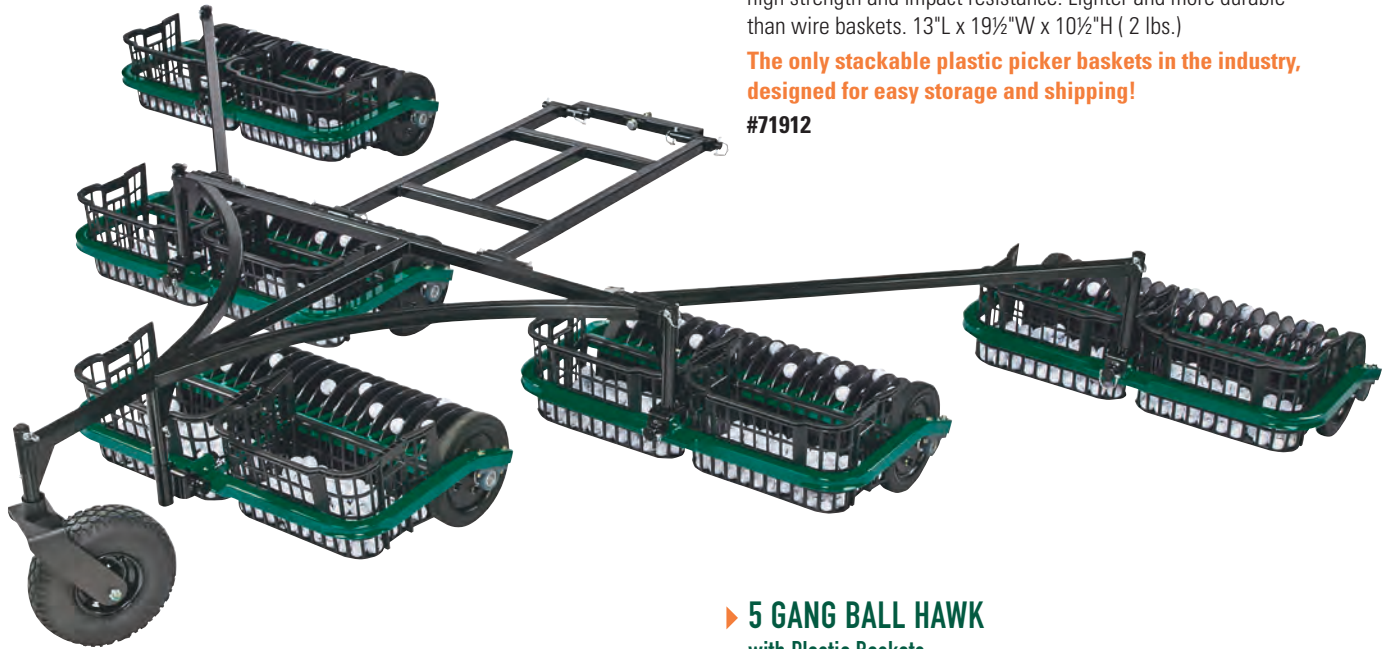

▶ **5 GANG BALL HAWK**

with Plastic Baskets

15' wide, and comes complete with push bar and mounting bracket. Weight 585 lbs. **Holds 3,000 balls.**

#71405P - Black Discs

#71405PW - White Discs



EXTRA HEAVY DUTY POST ASSEMBLIES

The only solid steel post assemblies in the industry provide greater strength and performance.



ANOTHER WITTEK EXCLUSIVE

The 1½" square tubing - largest in the industry! A powder coat finish results in high strength and long lasting performance and protection.

ACCESSORIES & PARTS

See Pg 104 for Complete Diagram and parts list.

#71920 - Replacement Black Drum Section

#71920W - Replacement White Drum Section

#71801 - Pillow Block Bearings

#71989 - Front Wheel/Tire/Axle/Bearings

#71979 - Ball Hawk Caster Fork

#71919 - Tie Rods (including hardware)

#71932 - Disc Only - Black

#71932W - Disc Only - White

See your invoices/statements @ www.wittekgolf.com

EAGLE LITE PICKER

LIGHT MEETS MIGHT

The **lightest** ball retriever in the golf market. The Eagle Lite puts less pressure on the cart and allows for **faster picking time**. The newest edition to the Pro Line Series.

*The picker of choice at the
2018 U.S. Open Championship!*

Benefits

- Less Pressure on Cart
- Faster Picking Time
- Lightest Ball Retriever in the market
- Stronger Nylon Discs
- Bearingless Picker
- Reversible

REVERSIBLE



▶ 3 GANG EAGLE LITE

with Plastic Baskets

ONLY 240 pounds. It is 9' wide. Comes complete with push bar and mounting bracket.

Holds 1,800 balls.

#71423P - Black Discs

#71423PW - White Discs

ADDITIONAL FEATURES



NEWLY DESIGNED NYLON WHITE AND BLACK DISCS

These lightweight, durable discs, maximize productivity on the range. Drums come standard with black discs. Upgrade to white for soft cover balls.



FRONT WHEEL PACKAGE

Front wheel bracket and wheel allow added maneuverability when picking the range.



ELBOW

The only solid steel elbow in the industry, provides greater strength and performance.



STACKABLE



Durability

It's light, but built strong.

- 1 ¼" Powder Coated Steel Framework
- Solid Steel Posts
- All Nylon Discs
- Plastic Baskets
- Adjustable axle brackets

▶ **PLASTIC PICKER BASKETS**

300 Balls Per Basket

Our picker baskets are made of a tough polyethylene that offers high strength and impact resistance. Lighter and more durable than wire baskets. 13"L x 19½"W x 10½"H (2 lbs.)

The only stackable plastic picker baskets in the industry, designed for easy storage and shipping!

#71912



▶ **5 GANG EAGLE LITE**

with Plastic Baskets

ONLY 470 pounds, it is 15' wide. Comes complete with push bar and mounting bracket. **Holds 3,000 balls.**

#71425P - Black Discs

#71425PW - White Discs



ANOTHER WITTEK EXCLUSIVE

1¼" square tubing - the strongest tubing used in a lightweight picker! A powder coat finish results in high strength and long lasting performance and protection.

ACCESSORIES & PARTS

See Pg 104 for Complete Diagram and parts list.

#71922 - Black Drum (includes axle bracket set)

#71923 - White Drum (includes axle bracket set)

#WGRM036 - Disc Only - Black

#WGRM037 - Disc Only - White

#71760 - Adjustable Drum Brackets set

#71761 - Front Post Assembly

#71762 - Back Post Assembly

#71763 - Front Wheel Package

Order online 24/7 @ www.wittekgolf.com

SL90-STRAIGHT LINE PICKERS

A NEW LEVEL OF PRODUCTIVITY

Coverage

Covers more terrain in less time.

Maneuverability

The SL90 Series Ball Picker has a 360 degree turning radius, allowing for effortless back up and turning. Can be pushed or pulled.

Durability

Super strong yet lightweight Tubular steel construction creates a ball picker with unsurpassed reliability. Fewer moving parts and straight-line design helps on extra tough terrain.

REVERSIBLE DRIVE



▶ SL90 SUPER LIGHTWEIGHT

with Plastic Baskets

Five sections. 18' wide with a ball capacity of 3,000.

#71840P - Black Discs

#71840PW - White Discs

ADDITIONAL FEATURES



NEWLY DESIGNED COMPOSITE WHITE AND BLACK DISCS

These lightweight, durable discs, maximize productivity on the range. Drums come standard with black discs. Upgrade to white for soft cover balls.



ALL-IN-ONE SWIVEL CASTER FORK AND WHEEL

Provides more control, flexibility and maneuvering ability than any other picker on the market.



NEVER-MISS BALL DEFLECTORS

Perfectly designed adjustable deflectors mean you will "never-miss" a ball again.



STACKABLE



▶ **PLASTIC PICKER BASKETS**

300 Balls Per Basket

Our picker baskets are made of a tough polyethylene that offers high strength and impact resistance. Lighter and more durable than wire baskets. 13"L x 19½"W x 10½"H (2 lbs.)

The only stackable plastic picker baskets in the industry, designed for easy storage and shipping!

#71912



▶ **SL90 SENIOR LIGHTWEIGHT**
with Plastic Baskets

Three sections, 10' 7" wide with a ball capacity of 1,800. Weight 375 lbs.

#71830P - Black Discs

#71830PW - White Discs



▶ **SL90 JUNIOR LIGHTWEIGHT**
with Plastic Baskets

Two sections, 7' wide, with a ball capacity of 1,200. Weight 317 lbs.

#71820P - Black Discs

#71820PW - White Discs



SL90 A-FRAME

Required attachment for pushing the SL90 Series pickers. Complete with three couplers and 9' 6" long (Junior, Senior) or 11' 3" long (Super), with 3' adjustable spread.

#71601 - For Junior & Senior

#71603 - For Super

ACCESSORIES & PARTS

See Pg 104 for Complete Diagram and parts list.

#71920 - Replacement Drum Section

#71920W - Replacement White Drum Section

#71801 - Pillow Block Bearings

#71989 - Front Wheel/Tire/Axle/Bearings (specify type)

#71936 - Swivel Caster Fork (specify type)

#71919 - Tie Rods (including hardware)

#71932 - Disc Only - Black

#71932W - Disc Only - White

Check your order history @ www.wittekgolf.com

PICKER ACCESSORIES



▶ THE PROTECTOR

Eliminates the need for heavy, expensive cages. Netting is made of strong, lightweight polypropylene. Allows constant air flow while protecting the driver. One size fits all rooftop carts. 44"W x 55"L Weight: 14 lbs.

#93527



▶ BALL HAWK, RANGE ROVER, & EAGLE LITE GOLF CART ADAPTERS

Specify year and model of golf car when ordering
Weight: 40–60 lbs.

#71927 - Yamaha, G-16, G-21, G-23

#71490 - Yamaha, G-27 & G-28 only

#71943 - Yamaha Adventure 1&2, Drive

#71928 - Club Car

#71951 - E-Z-Go Workhorse (specify year and style)

#71952 - E-Z-Go hauler 1200



▶ CONVERSION KIT

Contains all the necessary parts and attachments to convert your 3 Gang Ball Hawk & Range Rover to a 5 Gang. Plastic baskets included. Weight: 215 lbs.

#71404 - For Ball Hawk

#71402 - For Range Rover

#71422B - For Eagle Lite (Black)

#71422W - For Eagle Lite (White)



▶ SL90 A-FRAME

Required attachment for pushing the SL90 Series pickers. Complete with three couplers and 9' 6" long (Junior, Senior) or 11' 3" long (Super), with 3' adjustable spread.

#71601 - For Junior & Senior

#71603 - For Super



▶ SL90 GOLF CART ADAPTER

For mounting the SL90 to any conventional golf cart or utility vehicle. Complete with two ball hitches for securing A-frame. Specify year and model of golf cart when ordering. Weight: 40–60 lbs.

#71992 - E-Z-Go Workhorse (2001 to Current)

#71997 - Yamaha, G-16, G-21, G-23 only

#71890 - Yamaha, G-27 & G-28 only

#71977 - Yamaha, Adventure 1&2, Drive

#71998 - Club Car

#71999 - E-Z-Go hauler 1200



▶ SL90 CONVERSION KITS

Convert your present SL90 Ball Picker to a larger model. Kits include all necessary parts and outrigger attachments.

#71851 - Junior to Senior SL90

#71826 - Junior to Super SL90

#71852 - Senior to Super SL90

PICKER ACCESSORIES



▶ PLASTIC PICKER BASKETS 300 BALLS PER BASKET

Our picker baskets are made of a tough polyethylene that offers high strength and impact resistance. Lighter and more durable than wire baskets. 13"L x 19½"W x 10½"H (2 lbs.)

#71912



▶ REPLACEMENT PARTS

#71920 - Replacement Drum Section

#71920W - Replacement White Drum Section

#71801 - Pillow Block Bearings

#71919 - Tie Rods (including hardware)

#WGRM036 - Disc Only - Black

#WGRM037 - Disc Only - White

#WGEZ21N - Easy-Picker 21Disc Drum Section

#WGRM020S - Easy-Picker/Range Mate Picker Basket

#71922 - Eagle Lite Black Drum Section (includes axle bracket set)

#71923 - Eagle Lite White Drum Section (includes axle bracket set)

#71989 - Front Wheel/Tire/Axle/Bearings

#71936 - Swivel Caster Fork (for Range Rover & SL90)

#71979 - Caster Fork (for Ball Hawk)

#71811 - Wittek Tire Picker Drum Section

#71818 - Commercial Tire Picker Wire Basket

50G SUPERWASH BALL WASHER

DOUBLE THE OUTPUT

Delivers 20,000 sparkling clean range balls per hour to the tee line!
Over 15 Feet of double cleaning power! All-weather motor cover protects against sun, rain and weather. 1/2 H.P. high torque gear motor.



Comes with Dolly

20,000 BALLS PER HOUR



▶ WITTEK 50G SUPERWASH

Designed with "Soft Touch" Brush Lined Drum.

Reversible Brush Drum-extends the life of the brush drum against regular wear. Basket kick-stand keeps washer open for easy maintenance.

Weight: 221 lbs. Color: Black

Size: 52"L x 48"W x 50"H.

Tank capacity: 16 gallons

Hopper capacity: 350 golf balls

Electrical: 110 volt

Motor: 1/2 H.P. Drive motor

#73610

#73610-220V - 220 Volt



ACCESSORIES & PARTS

50G SUPERWASH

A. #73611 - Replacement Brush Drum 16.5" D x 16" W (52 lbs.)

B. #73578 - Bearings with Housing

C. #73186 - Drive Coupling

D. #73566 - Rubber Strip Set (2 lbs.)

E. #73179 - Vibrator Motor With Mounting Bracket

F. #73167 - Exit Chute

G. #73193 - Wire Hopper

H. #73571 - Wheel for Dolly

I. #M-73-26 - Valve

J. #73580 - 50G Guide Set Assembly

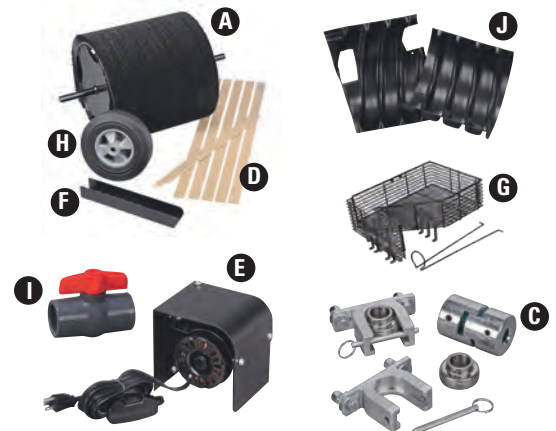

50G JUNIOR BALL WASHER

WASHES 10,000

Sparkling clean range balls per hour. Over 9 Feet of double cleaning power! All-weather motor cover protects against sun, rain and weather. 1/4 H.P. high torque gear motor.



Comes with Dolly

10,000 BALLS PER HOUR



▶ WITTEK 50G JUNIOR

Designed with "Soft Touch" Brush Lined Drum. Reversible Brush Drum-extends the life of the brush drum against regular wear. Basket kick-stand keeps washer open for easy maintenance.

Weight: 190 lbs.

Color: Black

Size: 35"L x 39"W x 41"H.

Tank Capacity: 8 gallons

Hopper Capacity: 350 golf balls

Electrical: 110 volt

Motor: 1/4 H.P. Drive Motor

#73650

#73650-220V - 220 Volt



50G JUNIOR

- A. #73651 - Replacement Brush Drum 9"D x 12" W (20 lbs.)
- B. #73578 - Bearings with Housing
- C. #73186 - Drive Coupling
- D. #73587 - Rubber Strip Set
- E. #73179 - Vibrator Motor With Mounting Bracket
- F. #73167 - Exit Chute
- G. #73193 - Wire Hopper
- H. #73571 - Wheel for Dolly
- I. #M-77-59 - Valve
- J. #73655 - 50G Junior Guide Set Assembly



▶ GOLF BALL SOAP POWDER

A mild, low sudsing detergent that eliminates dirt and grime.

5 lb. container. Color is purple.
10" H x 4.5 W (4 lbs.)

#73185



▶ GOLF BALL SOAP LIQUID

Antibacterial and odor-control agents. 1 Gallon Container.

12" H x 6" W (9 lbs.)

#73187

Reorder easily @ www.wittekgolf.com

WITTEK TWIST

The Twist is the latest addition to our already award-winning washer lineup. The Wittek Twist is made in the U.S.A of heavy gauge galvanized steel, a powerful drive motor and a self-contained water tank. The compact design is the perfect choice for low to medium volume golf courses and driving ranges.



- 1 Year Warranty
- Drain Valve Kit Included
- Heavy duty nylon brush
- Unique Steel Spiral
- Debris Removal
- Motor is sealed against sun and moisture
- Heavy gauge steel
- CLEANING RATE: 15,000 Ball/Hour
- HOPPER CAPACITY: 500 Balls
- WATER CAPACITY: 8 Gallons
- ELECTRICAL: 110 or 220 Volt
- MOTOR: 1/3 HP
- DIMENSIONS: 33L x 19W x 30.5H
- WEIGHT: 94 lbs.

#73489

ACCESSORIES & PARTS

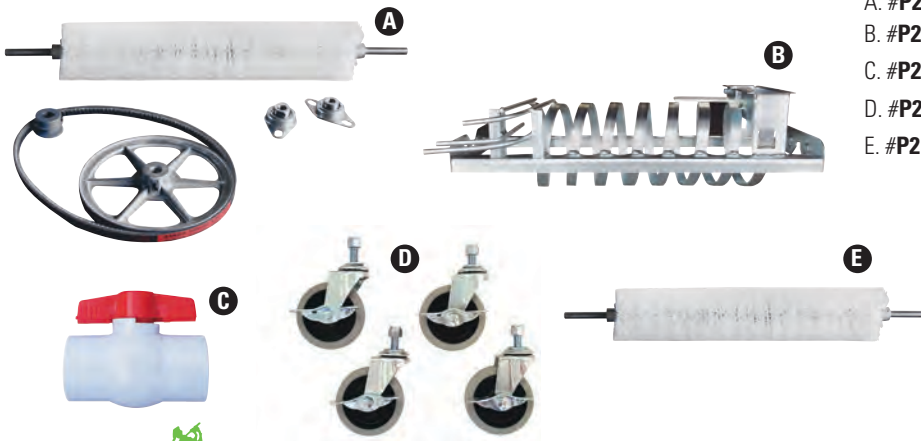

A. **#P2BW16** - Original Washer Rebuild Kit

B. **#P2BW10** - Original Spiral

C. **#P2BW17** - Original Drain Valve

D. **#P2BW18** - Original Wheel Kit

E. **#P2BW07** - Original Brush On Shaft

One-ball-at-a-time vending!

THE WITTEK ELITE SERIES DISPENSER

▶ VENDING COMBINATIONS

- #74760 - Token Only
- #74761 - Bill Acceptor Only -
- #74763 - Token/Bill Acceptor -
- #74759 - Dispenser Only -
- Upgrade** - 220 Volt .

1. DROP COIN MECHANISM

▶ DROP COIN MECHANISM

- Uses slotted security tokens.
- Built in coin return.
- Mechanism easily removable for cleaning.

#M-74-235 - Token



2. CASH

▶ BILL ACCEPTOR

- High acceptance rate in any direction.
- Low maintenance.
- Self diagnostic front color LED.

#74760 - Bill Acceptor

3. CROSSFIRE

▶ CROSSFIRE

- Accept credit cards right at your ball dispenser.
- Affordable; quick return on investment.
- Accept \$ Bills at Ball Dispenser (Optional.)
- Reduces token abuse.
- Secure Transactions.
- Reduce employee time.

#74236 - Crossfire Kit - 3 Button Swipe

#74238 - Crossfire - 3 Button Swipe w/ Bill Acceptor

4. E-RANGE

▶ RANGE MANAGEMENT SOLUTIONS FOR:

Version 8.0 require any printer capable of printing on 8.5" x 11" paper to print reports. Requires any POS or receipt printer with an installed compatible windows printer driver. Additional hardware for communication is included.

Eliminate tokens; use wireless PIN numbers to activate your ball dispenser. POS integration; print wireless PIN numbers right on your POS receipt!

#74323 - E-Range

#74325 - E-Key



▶ ELITE SERIES BALL DISPENSER

- **ACCOUNTABILITY.** Our ball dispensers provide features and benefits far beyond other models. Account management, sales tracking, and cash accountability are just a few of the operational tools to help you evaluate, analyze, and control driving range ball sales.
- **FLEXIBILITY.** Utilizing our **one-ball-at-a-time vending**, you have the ability to deliver any number of balls in up to three bucket sizes. This means you can effectively boost sales by configuring a bucket pricing structure best suited to your facility.
- **CONVENIENCE.** By offering multiple payment options and locating the ball dispenser near the tee line your customer may conveniently make additional purchases. For the operator, this means increased sales revenue and a reduction in operating costs.
- Customized payment options: PIN, e-key, cash, and credit card.
- 10,000 ball capacity.
- Vends eleven balls per second.
- Front or rear load machines available.
- Token style supplies one bucket size reliably time after time after time 63" H x 36" L x 42" W (494 lbs.).

Use your terms @ www.wittekgolf.com

SIGNATURE BALL DISPENSER

Electrically operated, fully customizable and easy to use. The Wittek Signature Dispenser has five vending options available: Tokens, Bill Acceptor, Golf Key Debit System, E-Range and Credit Card. All five options can be used, either separately or in any combination. Options can also be easily added at a later date. Electrical: 110 Volt.



▶ THE SIGNATURE SPECS:

Size: 65"H x 39"W x 46"D. Weight: 615 lbs. (w/skid)

Ball Count: Can be set to deliver 25, 30, 35, 40, 45 or 50 balls. (please specify when ordering).

▶ VENDING COMBINATIONS

#74750 - Dispenser Only

#74751 - Token Only

#74752 - Bill Acceptor Only

#74753 - Golf Key Only

#74754 - Token/Bill Acceptor

#74755 - Token/Golf Key

#74756 - Bill Acceptor/Golf Key

#74757 - Token/Bill Acceptor/Golf Key

#74758 - E-Range

Upgrade - 220 Volt



Sliding security door for nighttime protection



Hinged rear panel to allow easier ball loading



Easy access

VENDING OPTIONS

1. TOKENS



#74256



#74257



#74258



#74259



#74260



#74331



#74332



#74333



#74334



#74335



#74247



#74248



#74250



#74253

TOKENS

User friendly for your range customers. Sold in bags of 100. Bag dim. 9" x 7" x 1" (1.2 lbs.)

#74256 - "A" Token

#74257 - "B" Token

#74258 - "C" Token

#74259 - "D" Token

#74260 - "E" Token

#74331 - #3 Medium Brass

#74332 - #5 Large Brass

#74333 - #2 Small Silver

#74334 - #4 Medium Silver

#74335 - #6 Large Silver

#74247 - 4-Notch Round

#74248 - 3-Notch Round

#74250 - Butterfly

#74253 - Star

2. CASH

▶ BILL ACCEPTOR

- High acceptance rate in any direction.
- Low maintenance.
- Self diagnostic front color LED.

#74233 - Bill Acceptor



3. GOLF KEY

▶ GOLF KEY DEBIT SYSTEM

Easy Setup - User Friendly

- Prepayment of range balls reduces cash handling.
 - Easy for customers to use.
- Golf keys use high security smart chip technology. Credit value is added to the key with the Pro Shop terminal. At the dispenser key port, the LCD display shows the value on the Debit Key and asks to select a Small, Medium, or Large Pail. The value of the pail of balls is automatically debited off the key. It's as simple as that.

Unique ID to your dispenser

#74310 -



▶ GOLF KEY DEBIT SYSTEM INCLUDES:

- 1 Pro Shop Terminal with power supply.
- 1 Dispensing Terminal key port with LCD display and power supply.
- 5 Program keys
- Show Totals
- Decrease Price
- Increase Price
- Clear Totals
- Unlock
- Debit keys sold separately with no minimum order requirement.

#74311 - Keys Only



4. E-RANGE

▶ RANGE MANAGEMENT SOLUTIONS FOR:

Version 8.0 require any printer capable of printing on 8.5" x 11" paper to print reports. Requires any POS or receipt printer with an installed compatible windows printer driver. Additional hardware for communication is included.

Eliminate tokens; use wireless PIN numbers to activate your ball dispenser. POS integration; print wireless PIN numbers right on your POS receipt!

#74323 - E-Range

#74325 - E-Key -



BETTER MANAGEMENT, BIGGER PROFITS

e-range allows you to manage prepaid customer accounts; cash up front. It can pay for itself in less than a week. e-range can deactivate a lost or stolen account and replace it instantly with an accurate balance.

Uses Wireless Pin Numbers

1 Year Warranty On All Readers, Including Lightning Strikes!

#74325 - E-Key .



5. CROSSFIRE

▶ CROSSFIRE

- Accept credit cards right at your ball dispenser.
- Affordable; quick return on investment.
- Accept \$ Bills at Ball Dispenser (Optional.)
- Reduces token abuse.
- Secure Transactions.
- Reduce employee time.

#74236 - Crossfire Kit - 3 Button Swipe

#74238 - Crossfire - 3 Button Swipe w/ Bill Acceptor



DURA-TURF MAT

The Wittek Dura-Turf Mat uses the world's finest synthetic grass for a reliable mat that features a shock absorbing pad and reinforced tee hole.



▶ WITTEK DURA-TURF MAT

Thickness: 1¼"

Tee Holes: 5/8" Insert holes for rubber tees are centered on all sides and positioned 6 ½" inside the mat edge. Bottom side of holes are countersunk to accept base of rubber tee. 4 tee holes.

Size: 59" x 59"

Weight: 35 lbs.

#78183

FAIRWAY TURF MAT

This 100% nylon mat uses both straight and curled fibers. The straight fibers offer a nice fairway lie, while the curled fibers ensure the player a stable stance. The combination of these fibers creates no resistance at impact.

Tee Holes: 5/8" insert holes for rubber tees are centered on all sides and positioned 6 ½" inside the mat edge. Bottom side of holes are countersunk to accept base of rubber tee.

This mat gives the player the feel of hitting off fairways and tees.

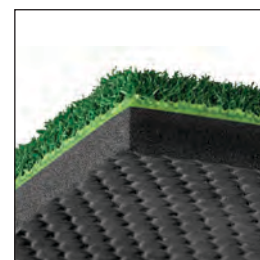

▶ FAIRWAY TURF MAT

Size: 59" x 59". Weight: 34 lbs

Thickness: 1¼" with pad.

#78186

QUATTRO MAT

The Quattro Mat is the most realistic simulation to a fairway on the market. Featuring an impact dampening system, which consists of highly elastic polyurethane fibers acting to absorb the impact of the club. The knitted nylon turf is bonded to an interface layer which protects the mat from tearing. Eight tee holes extend mat life. Bottom side of holes are countersunk to accept base of rubber tee.

Specially engineered to lessen the physical shock of club and body at impact.



▶ **QUATTRO MAT**
 Size: 59"x 59"
 Weight: 39 lbs.
 Thickness: 1¼"
#78180

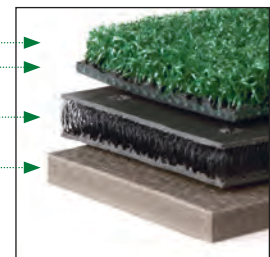

MEGA MAT

The closest you can get to real turf. This mat gives you the feel of real grass without the bounce of other mats. Wood tees can be used on this mat to further simulate real grass.



▶ **MEGA MAT**
 Size: 59"x 59"
 Weight: 41 lbs.
 Thickness: 1½"
#78197





▶ TEACHING MAT

Used to show proper alignment and swing path. All line on the mat are permanently imbedded. Constructed of ½" nylon turf and secured to the foam base using a liquid urethane.

Tee Holes: ⅝" insert holes for rubber tees are centered on all sides and positioned 6½" inside the mat edge. Bottom side of holes are counter sunk to accept base of rubber tee.

Thickness: 1¼" with pad

Size: 59" x 59"

Weight 35 lbs.

#78181



▶ ULTRA MAT

The AstroTurf Mat is made of tough nylon grass blades, with a knitted fabric and cushion pad system designed to absorb club head shock. Ultra Mats remain resilient and resist fatigue stroke after stroke.

#78184



▶ WITTEK TEE LINE TURF

- 100% Made in the U.S.A.
- Long lasting and durable
- 100% Nylon - No green residue on clubs.
- Quality Control - Vertical Integration of companies
- Satisfaction guaranteed or money back
- 3 Year warranty for any manufacturer defects
- No Cutting Fees
- Face weight: 110 oz/sy
- Pile height: 1⅛"

#78189

Call for more information.





► DURA RUBBER TEES

Featuring seven different sizes. Designed to fit all commercial driving range mats. Color: White. 50 tees poly-bagged. Weight 2 lbs. Made in USA. 2" diameter base. Packed 50/Bag.

- #78810 - 1 1/2" White
- #78811 - 1 3/4" White
- #78812 - 2" White
- #78813 - 2 1/4" White
- #78814 - 2 1/2" White
- #78815 - 2 3/4" White
- #78816 - 3" White
- #78827 - 3 1/4" White
- #78828 - 3 1/2" White



► RANGE ALIGNMENT ROPE

Easily set up your range with that perfect appearance. The rope is marked every 10' so the tee line is uniform for safety. It makes setting bag stands or tee dividers perfect every time. 6 1/2" x 6 1/2" (1 1/2 lbs.).

- #77210 - 100' Yellow
- #77211 - 100' Green/White

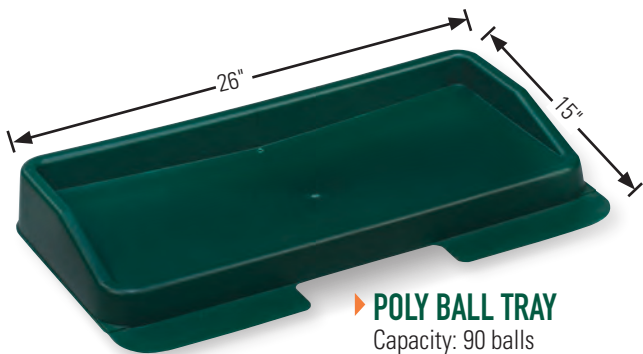

► POLY BALL TRAY

Capacity: 90 balls
Size: 26"W x 15"D x 3 1/2" H.
Weight: 3 lbs.

#76154

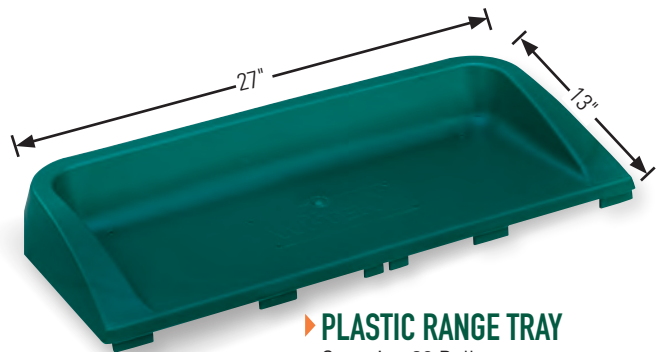

► PLASTIC RANGE TRAY

Capacity: 90 Balls.
Size: 27"W x 13"D x 3 1/2" H.
Weight: 2.5 lbs.

#76155

Check your order history @ www.wittekgolf.com

RANGE SUPPLIES

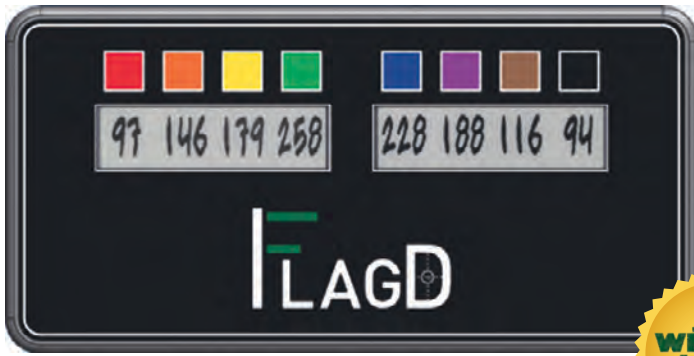

New in 2019

▶ FLAGD

FlagD distances are measured by determining GPS coordinates of targets on range (pins/flags) and providing information back to each FlagD unit. GPS coordinates taken once and programmed into each device upon initial setup. Individual devices "reset" each day by simply pressing button on back of unit with golf tee. This insures distances are calculated from exact spot where the FlagD device is located each day. Each device will display unique distances depending on its location on the range.

- #500001 - Plain Unit
- #500002 - Custom Unit
- #500003 - Artwork Charge (1 time)

▶ KENWOOD RADIOS

Kenwood Two-way Pro-Talk radios are built for all day, everyday use. Kenwood radios are known for their superb audio clarity, durability and ease of use. Our Pro-Talk radios are weather sealed and meet 11 military spec standards for use in all weather conditions. They range in power output from 1.5 to 5 watts and come with 2 year (analog radios) and 3 year (digital radios) warranties. Kenwood radios can also be programmed to talk with your existing analog radios at your request.

- A. TK-3230DX - 1.5 watt 6 channel UHF radio
- B. TK-2400V16P - 2 watt 16 channel VHF radio
- C. TK-2402U16P - 5 watt 16 channel VHF radio
- D. NX-240U16P - 5 watt 16 channel VHF digital radio
- E. NX-P500K - 2 watt 6 channel UHF digital radio

- A. KHS-31C - (C-ring headset)
- B. KHS-27 - (D-ring headset)
- C. KMC-21 - (Compact speaker mic)
- D. KMC-55W - (IP67 Speaker mic)

▶ FLAGD Caddy

Make your FlagD unit visible from anywhere on the range with this magnetized recycled plastic FlagD caddy.

- #405690BLK - Black
- #405690BRN - Brown
- #405690GRN - Green
- #405690DRT - Driftwood
- #405690WVN - Walnut



A. B. C. D. E.



A. B. C. D.



▶ WILSON RANGE BALL

Wilson's top range ball is available in White with Black stripes, White with Red stripes or Yellow with Black stripes. Packed 24 dozen per box.

- #72802 - White Ball/Black Stripes
- #72803 - White Ball/Red Stripes
- #72804 - Yellow Ball/Black Stripes



▶ FLOATER RANGE BALL

Designed and developed specifically for aqua ranges. Compression measures between 85 and 90. Two piece construction with good feel, click and distance. Packed 24 dozen per box.

- #72503 - White Ball /Black Stripes



▶ WILSON LIMITED RANGE

Wilson's limited flight range ball is designed for ranges with limited landing areas. Available in White with Black stripes or Yellow with Black stripes. Packed 24 dozen per box.

- #72902 - White Ball/Black Stripes
- #72904 - Yellow Ball/Black Stripes



▶ WOOD TEE HOLDERS

Designed for use with all grass mats. Holds a wooden golf tee that can be adjusted to the golfer's preference. Made in USA. Packed 50/Bag.

- #78823 - 1" Tee Holder
- #78820 - 1¼" Tee Holder
- #78824 - 1½" Tee Holder
- #78821 - 2" Tee Holder



▶ ADJUSTABLE RUBBER TEE

Eliminate all the different tee sizes with this one tee. Rubber tee adjusts from 2 1/8" to 3 1/4". Fits all traditional grass mats. 2" diameter base.

- #78825

▶ ALUMACAST RANGE WOODS

Durability and designed to handle day-to-day use. Made of one-piece aluminum casting. Neck area is reinforced with an iron shaft and wood dowel that runs through the entire head.

- #77215 - Men (RH) Black 43"
- #77216 - Men (LH) Black 43"
- #77217 - Women (RH) Light Blue 41"
- #77218 - Women (LH) Light Blue 41"
- #77219 - Junior (RH) Black 35"
- #77220 - Junior (LH) Black 35"



Chat with specialists @ www.wittekgolf.com

RANGE BAGS

CORDURA® STACKABLE RANGE BAGS

Our popular Cordura® bags are stackable and very durable. Featuring one-piece construction with square bottom.

Drawstring top with cord lock.

Available in 3 colors: Red, Green and Black.

Size	Ball Capacity	Red	Green	Black
Warm-Up	30	#76370	#76375	#76365
Small	45	#76371	#76376	#76366
Medium	65	#76372	#76377	#76367
Large	95	#76373	#76378	#76368



Large
Holds 95 balls

Medium
Holds 65 balls

Small
Holds 45 balls

Warm-Up
Holds 30 balls

CANVAS RANGE BAGS

A range favorite. These heavy duty cotton bags come with double cord drawstring and brass grommets.

Available in 3 colors: Red, Green and Black.

Size	Ball Capacity	Red	Green	Black
Warm-Up	30	#76300	#76305	#76340
Small	45	#76301	#76306	#76341
Medium	65	#76302	#76307	#76342
Large	95	#76303	#76308	#76343



Large
Holds 95 balls

Medium
Holds 65 balls

Small
Holds 45 balls

Warm-Up
Holds 30 balls

CANVAS PERSONALIZED RANGE BAGS

Cordura and canvas range bags can be enhanced by embroidering or screen-printing your name or logo. For logos, send us camera-ready art work by email. For names, simply spell out the name over the phone.

Art charges may apply. Please call for details.

#76304 -Art Set Up Fee



MESH RANGE BAGS

Lightweight and economical best describe our strong polyester mesh bags. Single draw string with cord lock.

Available in 4 colors: Royal Blue, Green, Yellow and Black.

Size	Ball Capacity	Royal Blue	Green	Yellow	Black
Warm-Up	30	#76310	#76315	#76320	#76324
Small	45	#76311	#76316	#76321	#76325
Medium	65	#76312	#76317	#76322	#76326
Large	95	#76313	#76318	#76323	#76327



Large
Holds 95 balls

Medium
Holds 65 balls

Small
Holds 45 balls

Warm-Up
Holds 30 balls

See page 18 for Range Balls

RANGE PAILS & BASKETS

Plastic baskets retain their strength even in extreme temperatures.



Utility Holds 300 balls Jumbo Holds 175 balls Large Holds 110 balls Medium Holds 75 balls Small Holds 50 balls Warm-Up Holds 30 balls

Size	Ball Capacity	Black	Green	Yellow	Height	Top Diameter
Warm-Up	30	#76289	#76291	#76295	5"	4½"
Small	50	#76277	#76280	#76286	5¾"	4¾"
Medium	75	#76278	#76281	#76287	8¾"	4¾"
Large	110	#76279	#76282	#76288	9½"	5¾"
Jumbo	175	#76290	#76292	#76296	8¾"	8¾"
Utility	350	#76273	#76274	#76276	11½"	12½"

▶ SUPER JUMBO UTILITY BASKETS

Convenient carry handles provide easy handling.

Holds over 600 golf balls.
Size: 14"H x 19" Top Diameter
Weight: 3.5 lbs.

#76462 - Green



▶ WINDY CITY CRATES

Made of durable Roto-molded plastic, these crates hold up to 300 balls. Simply rub the face of your iron across the soft bristle brush to release the balls.

#760ECBN - Brown -
#760ECGN - Green

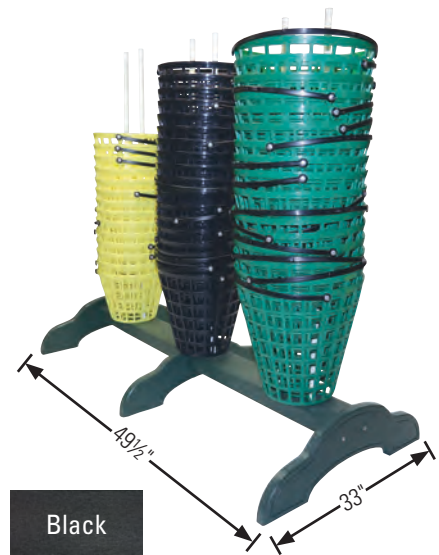

▶ STACKING CRATES

A mesh bottom so water drains through. Made of high density polyethylene.
Color: Red.

#76425 - Small -
Holds 276 balls
12" L x 16" W x 9" H (2 lbs.)
#76450 - Large
Holds 576 balls
16" L x 24" W x 9" H (3 lbs.)

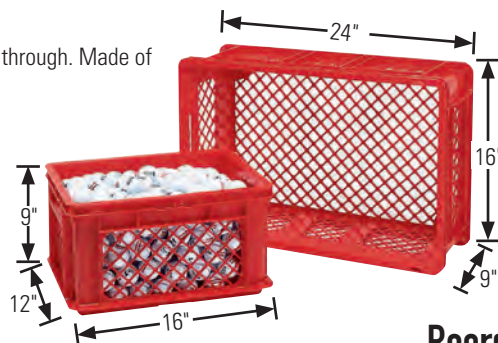

▶ RANGE PAIL ORGANIZER

Holds up to 75 pails. Goes well next to our Wittek Ball Dispensers, and a great way to clean up the range. Made from recycled plastic, so it will not rust.
Size: 33¼"H x 49½"W x 33"L.

Weight: 40 lbs.
#74481 - Green
#74482 - Black

Reorder easily @ www.wittek.com

RANGE SOLUTIONS



▶ THE ORIGINAL BAG SHAG

Made of heavy duty canvas with metal zippers.

Ball capacity: 75 Balls

7"L x 7"W x 27"H (2½ lbs.)

#77050 - Blue

#77051 - Red

#77053 - Black

#77054 - Hunter Green

#77052 - Camouflage

#77011 - Replacement Clips (3 Per Set)



▶ RANGER BAG SHAG

When bag is full, simply tip over to empty. Heavy weight nylon is water resistant. Metal supports prevent ripping. One year guarantee! 100 ball capacity. 7"L x 7"W x 27"H (2½ lbs.)

#77064 - Green

#77065 - Red

#77066 - Black



▶ PERSONALIZED BAG SHAGS

Imprint your range or course name!

Colors: Black, Red, Blue, Hunter Green.

Minimum order: 12.

Art charges may apply.

#77060 - Personalized Bag Shags

#76304 - One Time Art/Screen Charge

RANGE SOLUTIONS

RANGE EQUIPMENT

RANGE SUPPLIES

GOLF COURSE ACCESSORIES

IRRIGATION & MAINTENANCE

PRO SHOP ACCESSORIES

MINI GOLF

▶ HAV-A-BALL RANGE BALL PICKER

Works great under all conditions: Greens, fairways, rough, sand traps, even in standing water! (25 lbs.)

- Ideal for Hard to Reach Areas.
- Requires No Maintenance.
- Holds 25-30 dozen balls.
- Easy to assemble.

#71925 - Hav-A-Ball Picker -



▶ CLEAN SWEEP

Fast, efficient way to remove balls from your practice green. Lightweight, durable PVC construction rolls smoothly over the green.

Available in 42" and 52"

#77040 - Clean Sweep
42" Wide (5 lbs.)

#77045 - Jumbo Clean Sweep
52" wide (6 lbs.)



▶ BALS HAG TUBE WITH CAP

Picks up balls with ease, and the cap holds the balls in the tube. Made of aluminum. 23 ball capacity.

#77010 - Balshag Tube

#77011 - Replacement Clips (3 per set)

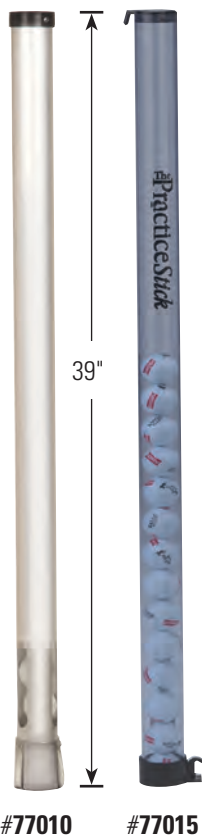

▶ BALL POPPER

Here's the best possible way to recover buried and embedded balls on your range.

Available in 55" and 37".

#77005 - Long Ball Popper,
55" Length (2½ lbs.)

#77006 - Shorty Ball Popper,
37" Length (2 lbs.)



▶ PRACTICE STICK

The durable Practice Stick retrieves up to 25 balls without having to bend over. Lightweight, all plastic construction.

#77015 - Practice Stick

Use your terms @ www.wittekgolf.com

BAG RACKS & STANDS



▶ ECONOMY CADDY RACK

Long lasting construction, made of 1" O.D. powder coated tubular steel. Stackable to conserve space. 25" L x 16" W x 25" H (7 lbs.)

#77526 - Dark Green
#77527 - Black



▶ PRO 2000 BAG STAND

Removable stopper to add sand for additional weight. 23" L x 16" W x 30" H (9 lbs.)

#77590 - Black
#77591 - Hunter Green

Patent No. 5,695,312



Top View



▶ PRO 2000 DELUXE BAG STAND

Two drink receptacles. Convenient twin trays. Three club rest slots on both sides. 22" L x 16" W x 31" H (11 lbs.)

#77530 - Black
#77531 - Hunter Green

▶ METAL BAG RACKS

This line features 1/8" PVC coating over zinc galvanized 2 3/8" round tubing. Expanded metal is also PVC coated. All fasteners are corrosion resistant.



#43260 - Single Bag Rest, 8' - Holds 8 Bags
6' L x 39" W x 32" H (170 lbs.)

#43265 - Single Bag Rest, 6' - Holds 6 Bags
6' L x 39" W x 32" H (170 lbs.)



#43250 - Double Bag Rest, 8' - Holds 16 Bags
8' L x 40" W x 32" H (230 lbs.)

#43255 - Double Bag Rest, 6' - Holds 8 Bags
6' L x 40" W x 32" H (170 lbs.)

RECYCLED PLASTIC

BAG RACKS & STANDS



▶ SINGLE POST BAG STAND

Designed for turf ranges, this unit has 3 spikes holding the stand in place, while also allowing for easy relocation. 8" L x 12" W x 30" H (5 lbs.)

- #P093BLK - Black
- #P093BRN - Brown
- #P093G - Green
- #P093D - Driftwood
- #P093WN - Walnut



▶ FOLDING BAG STAND

A favorite on ranges everywhere. Folds up for easy storage. Hole drilled for alignment stick. 22" L x 16" W x 33" H (11.5 lbs.)

- #54353 - Black
- #54354 - Brown
- #54355 - Green
- #54356 - Driftwood
- #54345WN - Walnut



▶ FOLDING BAG STAND with Cup Holder

This fold-up bag is a sharp addition to any area, with extra room for a drink holder. Hole drilled for alignment stick. 22" L x 19" W x 33" H (12 lbs.)

- #54351 - Black
- #54352 - Brown
- #54358 - Green
- #54357 - Driftwood
- #54352WN - Walnut

Color choices for all recycled plastic products

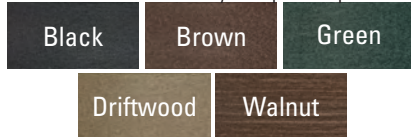

▶ MODULAR 5 BAG RACKS

This design is made from high quality GreenWood™ is great for around the clubhouse or restaurant. Each unit holds up to five bags and is exceptional in applications such as a wall mounting, back to back or side to side. Dimensions 67" L x 18" W x 32" H (64 lbs.).

- #C048BLK - Black
- #C048BRN - Brown
- #C048G - Green
- #C048D - Driftwood
- #C048WN - Walnut



See your invoices/statements @ www.wittekgolf.com

CLUB CLEANERS



▶ RANGE MATE CLUB WASHER

- Cleans woods, irons and grips.
 - Eliminates splashing.
 - Includes heavy duty powder coated wire stand.
- 22" H x 15" x 15" (top) 18 lbs.

#WGMB9106 - Green Club Washer

#WGMB9802 - Replacement Brush

#WGMB9800 - Replacement Brush Kit (2 Brushes, Frame, & Screws)



Color choices for all recycled plastic products

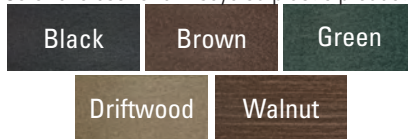

▶ RECYCLED CLUB WASHER

Rugged construction includes 5-gallon (19 L) bucket and hand brush.
32" H x 17" x 17" (top) 32 lbs.

#405550 - Green

#405551 - Brown

#405552 - Black

#405553 - Driftwood

#405551WN - Walnut

NEW in 2019



▶ WINDY CITY SERIES CLUB WASHER

- Club Washer includes 2 brushes and lid.
 - 8-Gallons (30L).
 - Attractive side panels dress up the range or tee area.
 - UV - Resistant.
- 19" H x 16" W x 16" D.

#778GN - Green

#778BN - Brown

#778BK - Black

#WG89802 - Replacement Brush



▶ DELUXE CLUB CLEANER

Recycled lumber frame contains the club cleaner. Two oversized 9" x 12" nylon brushes to ensure effective cleaning.

- Rotate brushes for even wear and double life.
 - Maintenance free exterior.
- 29" H x 14" x 14" (top) 21 lbs.

#77855 - Green

#77856 - Brown

#77858 - Black

#77859 - Driftwood

#77856WN - Walnut

#WGMB9802 - Replacement Brush

CLUB CLEANERS



Patent No. 5,695,312

▶ ADVANCED SPEEDEE CLUB CLEANER

Two rotating nylon brushes. One firm brush for irons, one soft brush for woods. Tank holds up to 4 gallons. Heavy-duty ¼ H.P. motor. Operates from 110 volt outlet. Sealed flange bearings assure no freeze up of rotating shaft. 24" H x 23" W x 19" D 85 lbs.

- #41200 - Advanced Speedy Club Cleaner .
- #41106 - Replacement Woods/Irons Brush Assembly (Mounted to Shaft)



▶ PRO 2000 CLUB CLEANER

Safely cleans woods and irons. Two sets of removable oversized soft nylon bristle brushes that insure safe and effective cleaning. Rotate brushes for even wear and double life. Ultra strong all polyethylene construction for long lasting wear. Comes with absorbent cotton towel. 24" H x 12.5" W x 16" D 21 lbs.

- #77880 - Hunter Green
- #77881 - Black



▶ ULTIMATE CLUB CLEANER

Bucket stands 18" high for fast and easy cleaning of irons. Two oversized (8½" x 10") nylon brushes to ensure effective cleaning. Rotate brushes for even wear and double life. Attached club rest. 19" H (with stand) x 12" x 12" (top) 13 lbs.

- #77834 - Green
- #77837 - Black
- #77840- Replacement Brush



▶ PRO 2000 CLEANING BRUSHES

New black level nylon brush is the proper type and size for optimum, safe and effective cleaning action. The ultimate brush in wet and dry brushing.

- #77803 - Replacement Brush For Woods .
- #77806 - Replacement Brush Irons (2 Required)

Order online 24/7 @ www.wittekgolf.com

PYRAMID SOLUTIONS



This pyramid builder conveniently loads from the top. It is fabricated out of galvanized steel with a choice of either steel or ABS plastic trays.

▶ METAL PYRAMID

- #76180 - Metal 55 Ball Pyramid Builder - 3 lbs.
- #76181 - Metal 91 Ball Pyramid Builder - 3.5 lbs.
- #76182 - Metal 140 Ball Pyramid Builder - 4 lbs.
- #76183 - Metal 204 Ball Pyramid Builder - 5 lbs.
- #76184 - Metal 285 Ball Pyramid Builder - 6 lbs.

▶ METAL PYRAMID TRAY ONLY

- #76185 - Metal 55 Ball Pyramid Tray - 1 lbs.
- #76186 - Metal 91 Ball Pyramid Tray - 1.3 lbs.
- #76187 - Metal 140 Ball Pyramid Tray - 1.7 lbs.
- #76188 - Metal 204 Ball Pyramid Tray - 2 lbs.
- #76189 - Metal 285 Ball Pyramid Tray - 3 lbs.

▶ PLASTIC PYRAMID TRAY ONLY

- #76190 - Plastic 55 Ball Pyramid Tray - 0.50 lbs.
- #76191 - Plastic 91 Ball Pyramid Tray - 0.75 lbs.
- #76192 - Plastic 140 Ball Pyramid Tray - 1 lbs.
- #76193 - Plastic 204 Ball Pyramid Tray - 1.25 lbs.

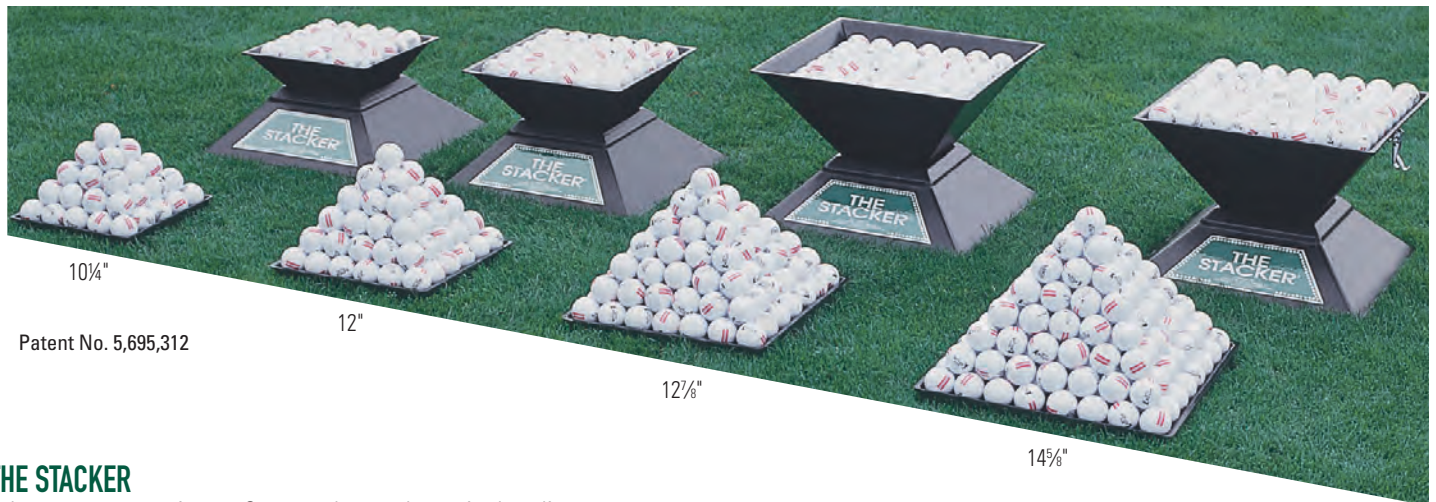

10 1/4"

12"

12 7/8"

14 5/8"

Patent No. 5,695,312

▶ THE STACKER

Enhance your course image. Create a clean and organized tee line while increasing labor efficiency. Ideal for special events! Fast and easy to use - simply pour balls into The Stacker, cover with tray and invert. Balls come out in a perfect pyramid every time. All kits include 15 trays.

- #76159 - 204 Ball Stacker Kit
- #76158 - 204 Ball Tray Only
- #76160 - 140 Ball Stacker Kit
- #76161 - 140 Ball Tray Only

- #76165 - 91 Ball Stacker Kit
- #76166 - 91 Ball Tray Only
- #76168 - 55 Ball Stacker Kit
- #76169 - 55 Ball Tray Only



▶ FORE-N-ONE

The Fore-N-One is an innovative new way to make four different sized pyramids (55, 91, 140, and 204) from one pyramid builder. The Small Fore-N-One makes both 55 and 91 ball pyramids. Just select the tray size and load balls into the top of the Fore-N-One. Then remove the Fore-N-One, and you're done! Kit includes one top loading unit. Trays sold separately (refer to Stacker Ball Trays Only).

Fore-N-One Pyramid Builder 15 1/4" L x 15 1/4" W x 14" H (5 lbs.)
Small Fore-N-One Pyramid Builder 12" L x 12" W x 13" H (3 lbs.)

- #76171 - Fore-N-One Pyramid Builder
- #76172 - Small Fore-N-One Pyramid Builder

TEE DIVIDERS



Logo Additional - Call to discuss custom options.



Flat

Vertical

Color choices for all recycled plastic products

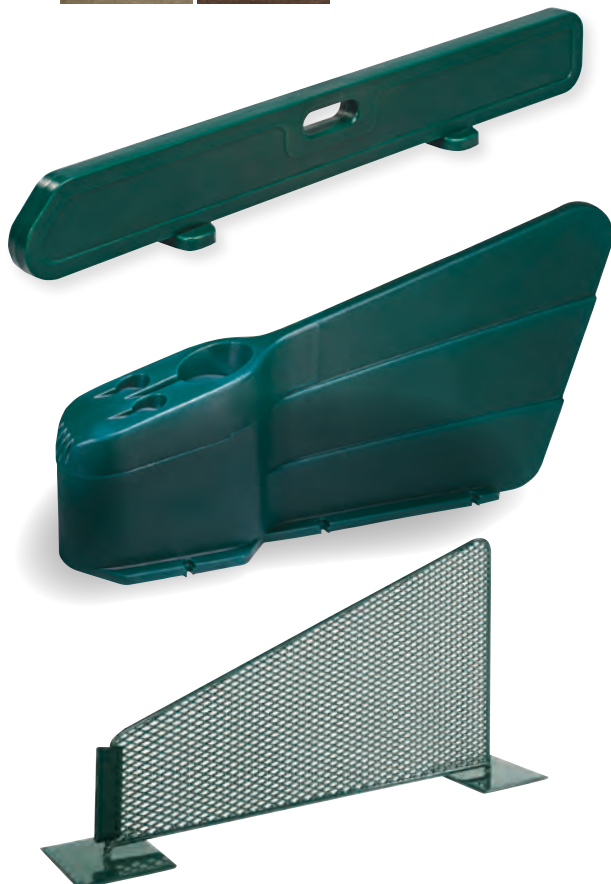
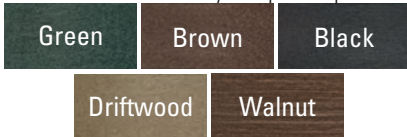

▶ CLASSIC RANGE DIVIDER

A moveable range divider that clearly delineates the hitting areas on the range. 14"H x 48"L 12 lbs.

- #P059AG - Green
- #P059ABLK - Black
- #P059ABRN - Brown
- #P059ADRT - Driftwood
- #P059AWN - Walnut

▶ TEE DIVIDERS/DIRECTIONAL ARROWS

- Keeps players in one designated teeing area on the range.
- Direct new players toward the next tee.
- Recycled plastic. 
- Comes with three steel stakes to hold in position.
- Can be personalized with your logo.

▶ RECYCLED PLASTIC FLAT ARROW

Size: 42"L x 3½"W x 1½"H (5 lbs.).

- #P051G - Green
- #P051BLK - Black
- #P051BRN - Brown
- #P051DRT - Driftwood
- #P051WN - Walnut

▶ RECYCLED PLASTIC VERTICAL ARROW

Size: 42"L x 1½"W x 3½"H (5 lbs.).

- #P056G - Green
- #P056BLK - Black
- #P056BRN - Brown
- #P056DRT - Driftwood
- #P056WN - Walnut

▶ COUNTRY CLUB TEE DIVIDER

- Long lasting polyethylene construction.
- UV stabilized to protect from fading.
- Comes with two 6" ground spikes.
- Custom colors available.

8"H x 52"L x 3"D 6 lbs.

#77715 - Hunter Green

▶ PRO 2000 TEE DIVIDER

- Long-lasting polyethylene construction.
- Built-in club rest holds up to four clubs.
- Holds beverage, keys, loose change and any size metal or plastic range pail.
- Designed for cement or grass tee areas.

30"H x 60"L x 13¾"D 9 lbs.

#77685 - Hunter Green

▶ MESH STEEL TEE DIVIDER

Keep your customers safe with this durable steel mesh tee divider. Rust proofed and then vinyl coated to keep them looking good for years to come. Optional bag stand available.

66"W x 32"H 9 lbs. Tee divider 41 lbs., Bag Stand 7 lbs.

- #77571 - Tee Divider
- #77572 - Bag Stand

Check your order history @ www.wittekgolf.com

A-FRAME YARDAGE SIGNS ½" THICK

A-Frame signs are the best way to keep your customers informed. Our custom range yardage signs can be made with either permanent or interchangeable yardages and can include logos or other messages. Made of super durable laminated plastic our A-Frames are made to last and look great for many years. Let our expert design staff create a sign that is perfect for you. Clock additions are available to ensure everyone makes their tee time. Two standard sizes to choose from, but can be customized to your specifications. Colors available colors: green, yellow, blue, black, red and brown.

▶ 17" W X 30" H



Give your golfers the yardages they need with these durable laminated plastic signs! Available single or double sided, with or without your logo or a clock. Yardage numbers and aluminum tracks are available in 2" and 3" sizes are fully interchangeable. Weight 22 lbs.

3 Yardages

#78450	Single Sided w/ 3 Yardages
#78451	Double Sided w/ 3 Yardages

4 Yardages

#78452	Single Sided w/ 4 Yardages
#78453	Double Sided w/ 4 Yardages

Call for a quote on signs with clocks/logos!

▶ 22" W X 32" H



Give your golfers the yardages they need with these durable laminated plastic signs! Available single or double sided, with or without your logo or a clock. Yardage numbers and aluminum tracks are available in 2" and 3" sizes are fully interchangeable. Weight 30 lbs.

5 Yardages

#78454	Single Sided w/ 5 Yardages
#78455	Double Sided w/ 5 Yardages

6 Yardages

#78456	Single Sided w/ 6 Yardages
#78457	Double Sided w/ 6 Yardages

7 Yardages

#78458	Single Sided w/ 7 Yardages
#78459	Double Sided w/ 7 Yardages

Call for a quote on signs with clocks/logos!

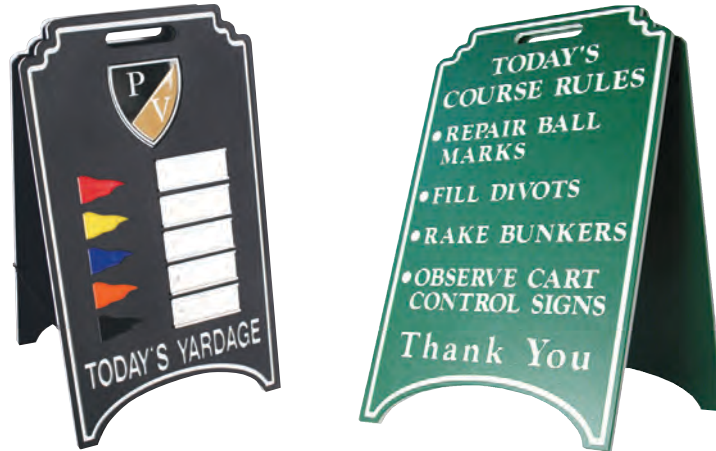

▶ 32" W X 40" H

Driving Range Yardage Sign With 12" Clock

Give your golfers the yardages they need with these durable laminated plastic signs! Available single or double sided, with or without your logo or a clock. Yardage numbers and aluminum tracks are available in 2" and 3" sizes are fully interchangeable.

6 Yardages

#78460	Single Sided w/ 6 Yardages & 12" Clock
#78461	Double Sided w/6 Yardages & 12" Clock

8 Yardages

#78464	Single Sided w/ 8 Yardages & 12" Clock
#78465	Double Sided w/ 8 Yardages & 12"Clock

Call for a quote on signs with clocks/logos!



Unlike other companies, our laminated plastic signs are all made in house. This means that they are fully customizable, and can be made in custom dimensions and engraved or Lexan logos, to meet your signage needs.

Call for a custom quote!



Chat with specialists @ www.wittekgolf.com

STARTER CLOCKS



Deluxe 18" Clock

12" Clock

▶ CLOCK-ON-POST

- Perfect for ranges or practice greens.
- Comes with sturdy stand alone support post which can be secured with spikes.
- Includes four ground spikes.
- Features a 12" clock.

4"W x 36"H x 4"D (22 lbs.)

#402580 - Black

#402581 - Green

▶ DELUXE CLOCK-ON-POST

Deluxe models feature 18" diameter atomic clock with built-in temperature and hydrometer gauges.

4"W x 48"H x 4"D (35 lbs.)

#402590 - Black

#402591 - Green



18" Atomic Clock

12" Clock

▶ REPLACEMENT CLOCKS

- Weather-resistant.
- Two models:
12" diameter Easel Replacement Clock.
18" diameter Deluxe Easel Atomic. Clock features built in temperature and hydrometer gauges.

12" Clock, White 1.5 lbs.

#77322 .

18" Atomic Clock, Silver 4 lbs.

#77323



12" Easel Clock

18" Deluxe Easel Clock

▶ EASEL CLOCKS (SINGLE-SIDED)

- A striking addition to #1 and #10 tee boxes and clubhouse.
- Easel clock features a 12" clock.
- Deluxe model features 18" diameter atomic clock with built-in temperature and hydrometer gauges.

Easel Clock- 16"W x 23"H (17 lbs.)

#402585

Deluxe Easel Clock- 28"W x 22"H (42 lbs.)

#402595



▶ PRO 2000 STARTER CLOCK/SIGN HOLDER

A clock on both sides to keep your golfers teeing off on time. Built-in handle allows easy mobility. Outdoor, all-weather clock's movement is sealed to keep moisture out. Clock runs on one AA battery (not included).

Size: 18½"W x 29"H.

Weight: 15 lbs.

#77325 - Black

#77327 - Green

BALL BARRIER NETTING

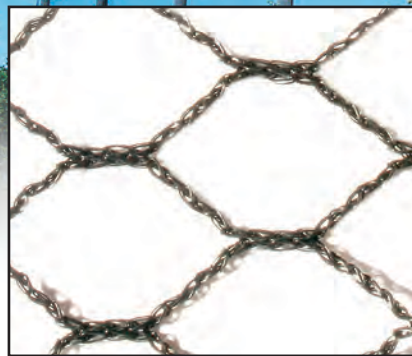

▶ ECONOMY NETTING

Made of 1" mesh knitted 100% polypropylene.
Break strength: 50 lbs.
Burst strength: 150 lbs.

SPECIFICATIONS

Fiber: 100% Polypropylene
Color: Black
Construction: Knitted
Break Strength: 50 lbs.
Burst Strength: 150 lbs.
UV Stabilizer: Carbon Black
Average field life: 10-12 years.
Approx. Percent Solid: 8%

#79300	6½' x 150'. Weight: 10 lbs.
#79301	12½' x 150'. Weight: 20 lbs.
#79302	25' x 100'. Weight: 27 lbs.
#79303	25' x 150'. Weight: 40 lbs.

▶ BALL BARRIER NETTING

Our most durable 1" mesh knitted netting that stops 'off course' balls. Featuring all new break strengths of 75 lbs. and 225 lbs. burst strength! Long life. Lasts an average of 10-15 years. Custom sizes available. Heights up to 50' in one piece. 100% polypropylene. Will not rot or mildew.

SPECIFICATIONS

Fiber: 100% Polypropylene
Color: Black
Construction: Knitted
Break Strength: 75 lbs.
Burst Strength: 225 lbs.
UV Stabilizer: Carbon Black
Average Field Life: 10 to 15 Years
Approx. Percent Solid: 10%

#79001	Netting - 6½' x 150' Weight: 20 lbs.
#79002	Netting - 12½' x 150' Weight: 40 lbs.
#79003	Netting - 25' x 100' Weight: 50 lbs.
#79004	Netting - 25' x 150' Weight: 75 lbs.
#79006	Netting - 37½' x 150' Weight: 125 lbs.
#79005	Netting - 50' x 150' Weight: 150 lbs.

▶ SYSTEM II NETTING (ROPE BORDER)

System II is found on more golf facilities than any other net. Rope bordered to your exact pole and cable centers makes snap hook installation a breeze. System II netting will not turn gray, rot or mildew. 10 year warranty. Complete packages including net, hardware and poles are available.

BORDERING COMPONENTS AND ATTACHMENT TWINE

3/8" diameter braided polypropylene cover over MFP parallel core 2840 lb. test. Used for netting perimeter, horizontal windlines and vertical riblines. Attachment twine #42 braided black polyester 440 lb. tensile strength. 5/16" snap hooks are then used to attach netting panels to all support cables on 2' centers. System II net panels are hand bordered to your exact dimensions.

SPECIFICATIONS

Product: 1" Mesh golf range netting
Fiber: Hi-tenacity polyester
Color: Black
Construction: Long stitch, knotless join
Break Strength: 100 lbs.
Burst Strength: 300 lbs.
UV Stabilizer: Impregnated
Average Field Life: 10 to 15 Years
Approx. Percent Solid: 8%

#79050

**CALL FOR HARDWARE
PRICING/ PACKAGES**

Reorder easily @ www.wittekgolf.com

PRACTICE NETS & CAGES

for Indoor or Outdoor Use



▶ THE ULTIMATE SPORTS CAGE

The affordable net system you've been asking for! Includes 8 specially designed corner brackets. You add the PVC pipe!*

- Ideal for all sports: golf, tennis, soccer, baseball, football, hockey.
- Safety net edging and loop fasteners. Ball never touches framework.
- Durable 100% nylon, hexagonal knotless mesh. Double stitched for maximum strength.
- U.V. Treated. Perfect for indoor and outdoor use.
- Includes baffle.

Color: Black. 10'L x 10'W x 10'H (21 lbs.)

*Requires (12) schedule 40 PVC pipe, 10' x 1 1/2" Diameter. Available at your hardware or home housewares store.

#79140



▶ POWER CAGE

New and improved for easy assembly and longer life. Ideal for golf shops and outdoor practice areas. A built-in double hitting wall withstands the strongest drives.

- Self standing cage assembles in minutes.
- Durable, lexan plastic posts and fittings snap together. No tools or hardware needed.
- One piece netting made of the finest 7/8" hi-tenacity black polyester. UV treated for outdoor use.
- Easy to assemble. Netting velcros to the frame.
- Diamond braid polyester rope cross members add stability and maximize wind-load protection.
- Includes 36" x 36" target.
- 10'H x 10'W x 10'D. Weight: 80 lbs.

Ships with UPS in 2 boxes.

#79150

▶ 3' x 3' Replacement Target For Power Cage

Heavy-duty 36" x 36" black target made of impact netting. Includes two 5' ropes to secure to framework. Weight 3 lbs.

#79151

PRACTICE NETS & CAGES

for Indoor or Outdoor Use

We specialize in custom made nets

Nets to fit any space, indoor or out. Nets are available for all forms of recreational use. Send us your specifications and we'll be happy to give you an estimate.

▶ W SERIES PRACTICE NET

Accommodate two practicing golfers. Specially treated for outdoor use.

- Net features top, sides, and back constructed of extra heavy knotless nylon.
- Black net comes with a rope border and 10'x20' baffle.
- 10'H x 20'W by 12' deep.
- Weight: 28 lbs. Ships UPS.

#W-1220 - Netting & Baffles Only.

Frame not included.



▶ HITTING TARGETS

Vinyl Targets, 18oz. black vinyl bulls eye sewn onto a white scrim material- complete with attaching ropes.

#79152 - 5' x 5' Hitting Target - Weight 3 lbs.

#79153 - 10' x 10' Hitting Target - Weight 5 lbs.



▶ BAFFLE NETS

Our baffle is made of heavy duty nylon construction. Available in two sizes, 4½' x 4½' and 10' x 9'.

#CBT-4 - 4½' x 4½' Weight: 2 lbs.

#CBT-9 - 10' x 9' Weight: 4 lbs.

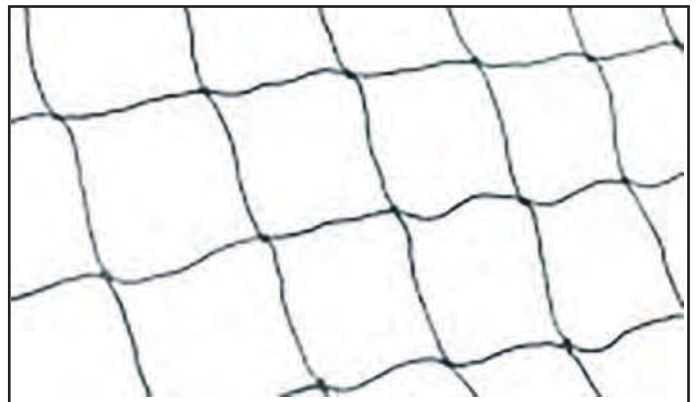

Use your terms @ www.wittekgolf.com

RANGE MARKINGS

▶ 3½" DIAMETER STRIPED YARDAGE POLES

For your range or golf course. Ideal for Fairway Markers.

Striped yardage poles are 3½" in diameter for easy visibility. Comes with one 12" steel ground anchor for easy installation and removal. Marker inserts 1' below ground. Weight: 7-13 lbs.

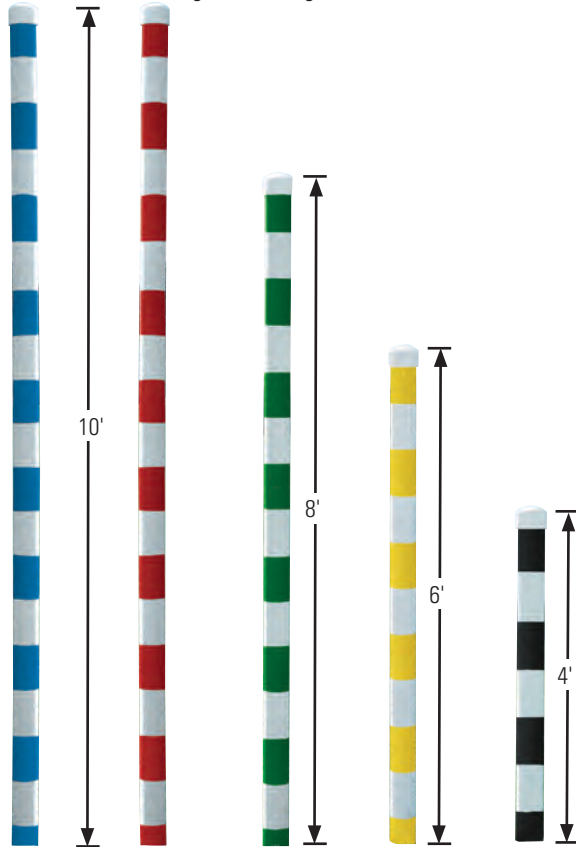

Add numerical suffix to item number for color choice:
 -1 Black, -2 Blue, -3 Green, -4 Red, -5 Yellow, -6 Orange

- #77265 - 4' - Weight 6 lbs.
- #77270 - 6' - Weight 9 lbs.
- #77275 - 8' - Weight 11 lbs.
- #77280 - 10' - Weight 13 lbs.

▶ METAL SLEEVE

In ground sleeve for yardage pole.
 12"H x 4"D

M-77-48



▶ WIND DIRECTION FLAG

Add a 13" x 19" wind direction flag to your yardage poles. Complete with rod. (Does not fit the 5" diameter poles). Weight 0.5 lbs.

- #77260 - Black
- #77261 - Green
- #77262 - Red
- #77263 - Yellow
- #77264 - White
- #77266 - Blue
- #77267 - Orange



▶ 5" DIAMETER, 8 FOOT STRIPED YARDAGE POLES

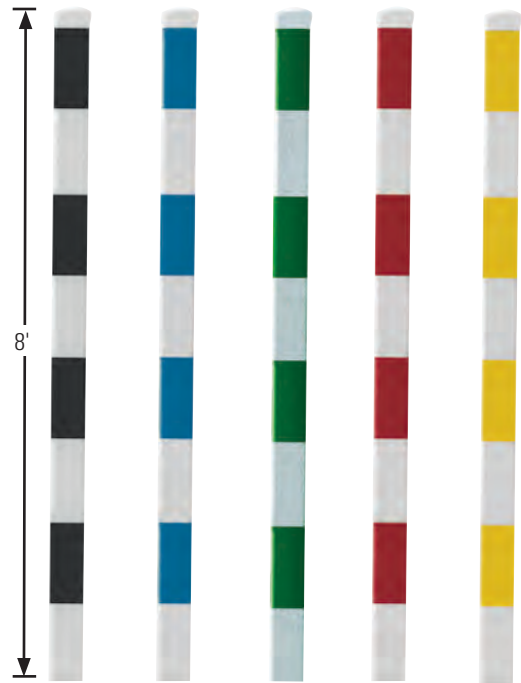

- #P075BLK - Black
- #P075B - Blue
- #P075G - Green
- #P075R - Red
- #P075Y - Yellow (13 lbs.)

▶ REFLECTIVE TAPE

- #P075RT - 3" Wide
- #P076RT - 6" Wide

▶ HIGHLIGHT YOUR RANGE WITH THESE OVERSIZED FLAGS

We manufacture high quality oversized 18" x 24" range flags. Easier to see at long distances, these 400 denier flags will last and last. All oversize flags are made Soft Pocket style.

- #401980 - Red
- #401981 - White
- #401982 - Yellow
- #401983 - Blue
- #401984 - Green



▶ SLEEVE

In ground sleeve for yardage pole
 12" x 12" x 17" H
 Weight 12 lbs

P075S



▶ FLAG EXTENSION PACKAGE

30" H Weight 1.2 lbs

P075T

Flags sold separately



RANGE MARKINGS



RANGE TARGETS

These fantastic targets are great for short game practice. Made using a sturdy Polybutylene frame with UV protected nylon netting and the bases are weighted for added stability. Includes yellow accent pads.

#79174 - Tee Target - 4' Diameter - Weight 24 lbs.



- #79178-25 25 Yard Target Net Yardage Plate
- #79178-50 50 Yard Target Net Yardage Plate
- #79178-75 75 Yard Target Net Yardage Plate
- #79178-100 100 Yard Target Net Yardage Plate

#P075RT - Reflective Tape Strip (3" W x 11.5" L)

RANGE BANNERS

High visibility and affordability have made our range banners a popular addition to ranges across the country.

- Bold yardages (50 to 300 yards) on bright yellow or green nylon.
- Each banner is sewn to fit a PVC frame that you can build yourself, or try our easy to assemble frame kit.

VERTICAL RANGE BANNER

Size 48"H x 24"W (Vertical)
Weight: .4 lbs.

HORIZONTAL RANGE BANNER

Size 24"H x 48"W (Horizontal)
Weight: .4 lbs.

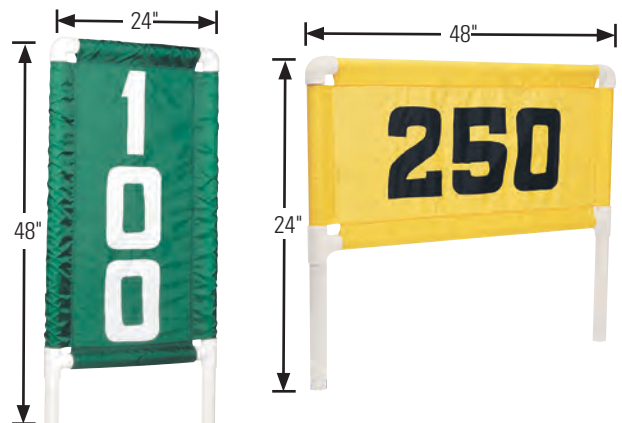

Length	Yellow/Black	Green/White	Yellow/Black	Green/White
50 Yards	31050VST	35050VST	31050HST	35050HST
75 Yards	31075VST	35075VST	31075HST	35075HST
100 Yards	31100VST	35100VST	31100HST	35100HST
125 Yards	31125VST	35125VST	31125HST	35125HST
150 Yards	31150VST	35150VST	31150HST	35150HST
175 Yards	31175VST	35175VST	31175HST	35175HST
200 Yards	31200VST	35200VST	31200HST	35200HST
225 Yards	31225VST	35225VST	31225HST	35225HST
250 Yards	31250VST	35250VST	31250HST	35250HST
275 Yards	31275VST	35275VST	31275HST	35275HST
300 Yards	31300VST	35300VST	31300HST	35300HST

RANGE BANNER FRAME KIT

Here's everything you need to build a frame for our Horizontal or Vertical Range Banners. Heavy-duty parts, drawing and instructions. Order one kit per banner.

#31000ST



Frame, tees and elbows 1/2" diameter. Ground anchors 10" long.

See your invoices/statements @ www.wittekgolf.com

RANGE MARKINGS

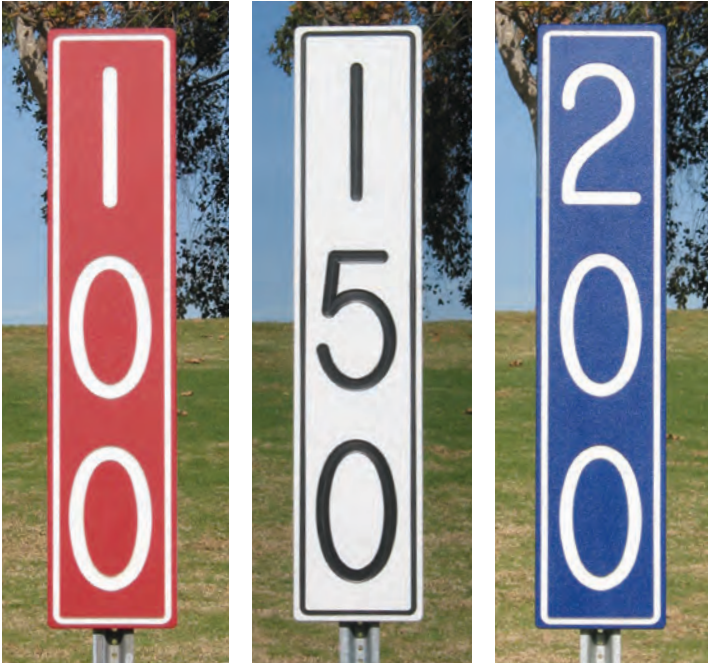

▶ VERTICAL YARDAGE MARKERS

Made using the same material as our horizontal yardage markers, these fantastic looking vertical yardage markers are virtually indestructible. Each marker measures 12" wide x 60" high and comes complete with a heavy gauge galvanized steel 8' post.

- #P0826R - ■ Red 100
- #P0826W - □ White 150
- #P0826B - ■ Blue 200
- #P0826Y - ■ Yellow 250



▶ HORIZONTAL YARDAGE MARKERS

Made from 3/4" engraved laminated plastic, our oval markers measure 47" wide x 30" high and are super easy to see. Each unit comes with two 4" x 4" recycled plastic posts with spikes that push easily into the ground.

- #P083R - ■ Red 100
- #P083W - □ White 150
- #P083B - ■ Blue 200
- #P083Y - ■ Yellow 250



▶ BULLS EYE MARKERS

Made using the same materials as our yardage markers shown above. These markers are 47" wide, 30" tall and come with two 4" x 4" recycled plastic posts. These markers are virtually indestructible!

- #P083Target

RANGE MARKINGS



EASY TO SEE FROM ANY DISTANCE!

▶ PRO 2000 VERTICAL YARDAGE MARKERS

For the Maximum in High Visibility. Molded plastic construction for long-lasting wear. Available in Green and Yellow. Comes with two 10' PVC ground anchors for easy installation. 55"H above ground. 12"W x 1.75"D. 10.60 lbs.

Yardage	Green/White	Yellow/Black
50 Yards	#77110	#77150
75 Yards	#77111	#77151
100 Yards	#77112	#77152
125 Yards	#77113	#77153
150 Yards	#77114	#77154
175 Yards	#77115	#77155
200 Yards	#77116	#77156
225 Yards	#77117	#77157
250 Yards	#77118	#77158
275 Yards	#77119	#77159

▶ PRO 2000 OVAL DISTANCE MARKERS

High visibility with long lasting polyethylene. Available in 2 sizes. UV stabilized to protect against fading. Comes with four 10" spikes and a metal in ground sleeve for mounting using a 2 x 4.

SMALL OVAL

Size 26"H x 31"W x 4"D Weight: 9.5 lbs.

Distance	Green/White	Yellow/Black
25 Yards	#77410	#77450
50 Yards	#77411	#77451
75 Yards	#77412	#77452
95 Yards	#77413	#77453

LARGE OVAL

Size 36"H x 47"W x 4"D Weight: 18 lbs.

Distance	Green/White	Yellow/Black
100 Yards	#77414	#77454
125 Yards	#77415	#77455
150 Yards	#77416	#77456
175 Yards	#77417	#77457
200 Yards	#77418	#77458
225 Yards	#77419	#77459
250 Yards	#77420	#77460
275 Yards	#77421	#77461
300 Yards	#77422	#77462

▶ PRO 2000 OVAL BULLSEYE MARKERS

High visibility with long lasting polyethylene. Available in 2 sizes



SMALL OVAL

31"L x 4"W x 26"H (9½ lbs.)

#77423 - Green
#77424 - Yellow

LARGE OVAL

47"L x 4"W x 36"H (18 lbs.)

#77425 - Green
#77426 - Yellow



Order online 24/7 @ www.wittekgolf.com

EMBROIDERED FLAGS 400 DENIER



13" x 19"

Our unique embroidery process using the highest quality threads makes every flag a show piece. All embroidered flags are done in house ensuring the highest stitch count and for fast turn arounds.



SOLID FLAGS 400 DENIER

Color	Tubed	Soft Pocket
Red	#401112-E	#401970-E
White	#401113-E	#401971-E
Yellow	#401114-E	#401972-E
Blue	#401103-E	#401973-E
Green	#401106-E	#401974-E
Black	#401102-E	#401975-E
Orange	#401108-E	#401976-E
Gold	#401107-E	#401978-E
Navy Blue	#401115-E	#401969-E
Pink	#401117-E	#401117-E
Purple	#401116-E	#401979-E



HANDLE & BORDER 400 DENIER

Color	Tubed	Soft Pocket
Red/Black Border	#401112-HE	#401970-HE
White/Black Border	#401103-HE-BLK	#401971-HE-BLK
White/Green Border	#401113-HE-G	#401971-HE-G
Yellow/Black Border	#401114-HE-BLK	#401972-HE-BLK
Yellow/Green Border	#401114-HE	#401972-HE
Blue/Black Border	#401103-HE	#401973-HE



▶ CHECKERED - WITH WINDOW 400 DENIER

Color	Tubed	Soft Pocket
Black / White Checks	#401731-W-E	#401995-W-E
Black / Yellow Checks	#401732-W-E	#401996-W-E
Blue / White Checks	#401733-W-E	#401997-W-E
Red / White Checks	#401734-W-E	#401998-W-E
Green /White Checks	#401735-W-E	#401999-W-E



▶ EMBROIDERED CUSTOM FLAGS 400 DENIER

The Wittek flag department are experts at designing and manufacturing all types of golf flags. Whether you want a Pennant style, Diagonal style, Multi striped, or anything you can imagine, give us a call and we will make sure you get just what you are looking for.



Check your order history @ www.wittekflag.com

SCREEN PRINTED FLAGS 400 DENIER



13" x 19"

▶ SOLID FLAGS 400 DENIER

Color	Tubed	Soft Pocket
Red	#401112-S	#401970-S
White	#401113-S	#401971-S
Yellow	#401114-S	#401972-S
Blue	#401103-S	#401973-S
Green	#401106-S	#401974-S
Black	#401102-S	#401975-S
Orange	#401108-S	#401976-S
Gold	#401107-S	#401978-S
Navy Blue	#401115-S	#401969-S



▶ HANDLE & BORDER 400 DENIER

Color	Tubed	Soft Pocket
Red/Black Border	#401112-HS	#401970-HS
White/Black Border	#401103-HS-BLK	#401971-HS-BLK
White/Green Border	#401113-HS-G	#401971-HS-G
Yellow/Black Border	#401114-HS-BLK	#401972-HS-BLK
Yellow/Green Border	#401114-HS	#401972-HS
Blue/Black Border	#401103-HS	#401973-HS



▶ CHECKERED – WITH WINDOW 400 DENIER

Color	Tubed	Soft Pocket
Black / White Checks	#401731-W-S	#401995-W-S
Black / Yellow Checks	#401732-W-S	#401996-W-S
Blue / White Checks	#401733-W-S	#401997-W-S
Red / White Checks	#401734-W-S	#401998-W-S
Green /White Checks	#401735-W-S	#401999-W-S

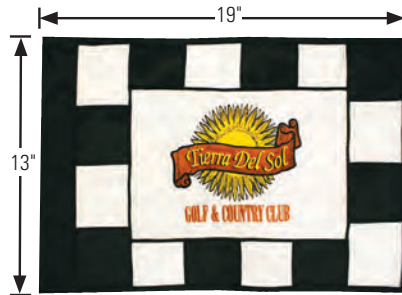

▶ CUSTOM SCREENED PRINTED FLAGS 400 DENIER



▶ DIGITAL & SPECIALTY

Digital or Dye Sublimated flags are a fantastic way to include intricately designed logos onto your golf flags. With the new digital processing procedure, golf flags can have all the colors of the rainbow gradually fading into one another. All Dye Sublimated flags are made Soft Pocket style.



Chat with specialists @ www.wittekgolf.com

PLAIN FLAGS 400 DENIER



13" x 19"

SOLID FLAGS 400 DENIER

Color	Tubed	Soft Pocket
Red	#401112	#401970
Blue	#401103	#401973
Orange	#401108	#401976
White	#401113	#401971
Green	#401106	#401974
Gold	#401107	#401978
Yellow	#401114	#401972
Black	#401102	#401975
Navy Blue	#401115	#401969
Purple	#401117	#401979
Pink	#401116	#401678



HANDLE & BORDER 400 DENIER

Color	Tubed	Soft Pocket
Red/Black Border	#401112-H	#401970-H
White/Black Border	#4011103-H-BLK	#401971-H-BLK
White/Green Border	#401113-H-G	#401971-H-G
Yellow/Black Border	#401114-H-BLK	#401972-H-BLK
Yellow/Green Border	#401114-H	#401972-H
Blue/Black Border	#401103-H	#401973-H

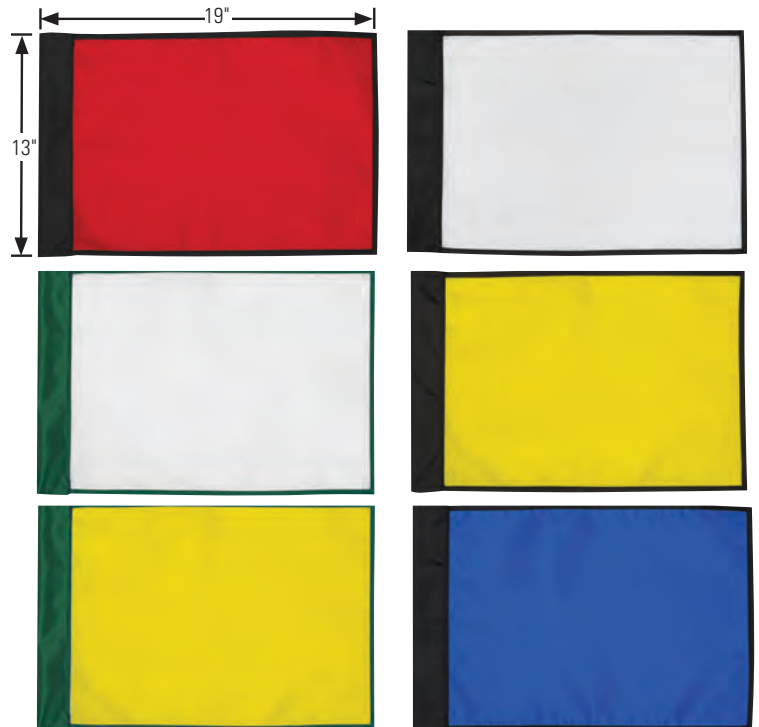

AMERICAN FLAG

A 12" x 18" high quality, durable American flag for your facility.

#G90012



CUT & STITCH - 400 DENIER CHECKERED FLAGS

Our cut and stitch applique process uses the same high quality 400 denier nylon and stitching process as our regular flags. Checkered flags are easily recognizable and are a great way to identify daily pin placements. Logos can be added to a center "window" by either silk screen or embroidery.

Call for Custom Colors!



Color	Tubed	Soft Pocket
Black / White Checks	#401731	#401995
Black / Yellow Checks	#401732	#401996
Blue / White Checks	#401733	#401997
Red / White Checks	#401734	#401998
Green /White Checks	#401735	#401999

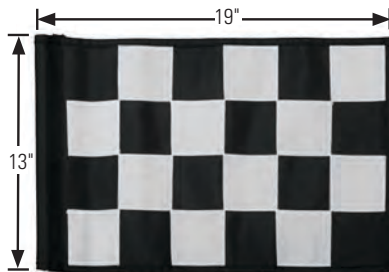

NUMBERED FLAGS - 400 DENIER

Sold In Sets Of 9 Only.

Color	Tube Lock 1-9	Tube Lock 10-18	Soft Pocket 1-9	Soft Pocket 10-18
White / Black Numbers	#401332	#401333	#401330	#401331
Blue / White Numbers	#401412	#401413	#401410	#401411
Red / White Numbers	#401392	#401393	#401390	#401391
Yellow / Black Numbers	#401372	#401373	#401370	#401371

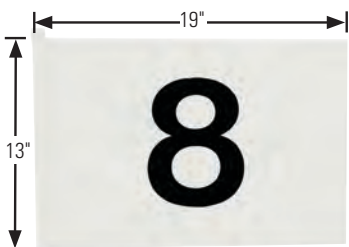

Reorder easily @ www.wittekgolf.com

WITTEK FLAGSTICKS

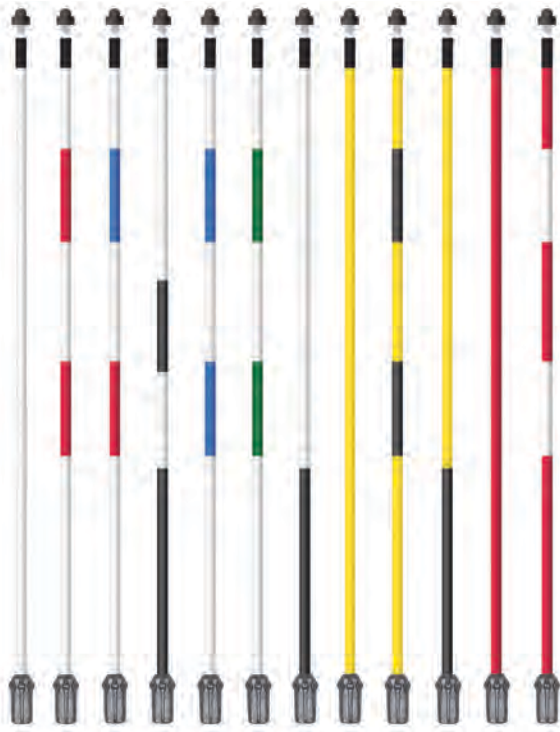

1/2" FLAGSTICKS

	#400415	7½' White
	#400416	7½' White with 2 Black Stripes
	#400417	7½' White with 2 Blue Stripes
	#400418	7½' White with 2 Green Stripes
	#400419	7½' White with 2 Red Stripes
	#400420	7½' White with 30" Black Bottom
	#400421	7½' Yellow
	#400422	7½' Yellow with 2 Black Stripes
	#400423	7½' Yellow with 30" Black Bottom
	#400411	5' White
	#400436	5' Yellow
	#400397	7½' White with Red & Blue Stripes
	#400416B	7½' British Black Stripes



Grooved Ferrule



3/4" TAPERED TOURNAMENT FLAGSTICKS

	#400424	7½' White
	#400425	7½' White with 2 Black Stripes
	#400426	7½' White with 2 Blue Stripes
	#400427	7½' White with 2 Green Stripes
	#400428	7½' White with 2 Red Stripes
	#400429	7½' White with 30" Black Bottom
	#400430	7½' Yellow
	#400431	7½' Yellow with 2 Black Stripes
	#400435	7½' Yellow with 30" Black Bottom

British Stripe



Regular Stripe



FERRULES AND TOPS

- A. #400412 - Black Acorn nut -
- B. #400408 - Aluminum Flag Pole Top
- C. #400407 - Zinc Ferrule
- D. #26512ST - Smartfit Ferrule
- E. #26517ST - Traditional Ferrule



PRISM LASER REFLECTOR

- Easily replaces acorn nut on Standard, Par Aide, and all other flagsticks with 3/8" - 24 threaded tip.
- Features nylon threads. No more metal-on-metal seizing associated with brass inserts.
- New five-glass prism pod design maximizes reflectivity, leaving no dead spots.
- Prisms snap into place for extra durability.



#402290



WITTEK FLAGSTICKS W/ VINYL GUARD

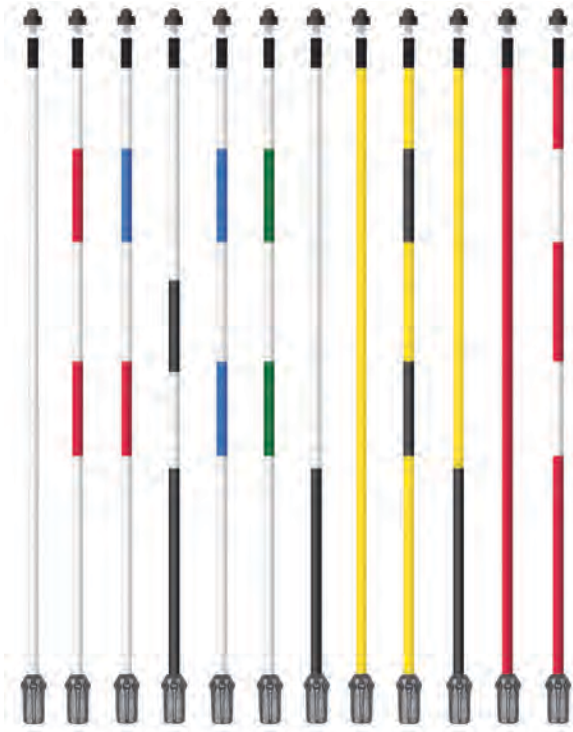

1/2" FLAGSTICKS

	#400415-V	7½' White
	#400416-V	7½' White with 2 Black Stripes
	#400417-V	7½' White with 2 Blue Stripes
	#400418-V	7½' White with 2 Green Stripes
	#400419-V	7½' White with 2 Red Stripes
	#400420-V	7½' White with 30" Black Bottom
	#400421-V	7½' Yellow
	#400422-V	7½' Yellow with 2 Black Stripes
	#400423-V	7½' Yellow with 30" Black Bottom
	400411-V	5' White
	400436-V	5' Yellow
	#400397-V	7½' White with Red & Blue Stripes
	#400416-BV	7½' British Black Strips



3/4" TAPERED TOURNAMENT FLAGSTICKS

	#400424-V	7½' White
	#400425-V	7½' White with 2 Black Stripes
	#400426-V	7½' White with 2 Blue Stripes
	#400427-V	7½' White with 2 Green Stripes
	#400428-V	7½' White with 2 Red Stripes
	#400429-V	7½' White with 30" Black Bottom
	#400430-V	7½' Yellow
	#400431-V	7½' Yellow with 2 Black Stripes
	#400435-V	7½' Yellow with 30" Black Bottom

▶ LASER REFLECTOR



The New Laser Reflector. Full 360° visibility, no dead spots, made with a highly reflective material with a large surface area. Fits both ½" regular poles and ¾" Tournament Poles. Sold in sets of 9

#400437

▶ ORIGINAL SPRYTE FLAG REFLECTOR



The original Spryte, Laser Reflective Top. Works great with all Laser Range Finders at a fraction of the cost of other reflective tops. The original 1.8" Spryte easily screws on the top of all flag sticks helping to speed up play with laser range finder players. The soft foam base will not break or damage greens when flag sticks are dropped. 2" W x 2" D

#400438

▶ SPRYTE ELITE FLAG REFLECTOR



The Spryte Elite. A slightly smaller version of the original Spryte Laser Reflector Top. This 1.25" reflector works just as well as the original but with a slightly smaller appearance and diameter. The Spryte Elite will help range finder players locate their targets quickly and easily. And best of all, they won't break your budget. 1.75" W x 1.25" D

#400439

Use your terms @ www.wittekgolf.com

FLAGSTICKS

TOURNAMENT FLAGSTICKS

Take advantage of the remarkable strength, visibility and wind resistance of the Tournament Flagstick. Extra heft in the center for added performance on greens. 1/2" diameter at both tip and ferrule; 3/4" diameter at the center. 7 1/2' - 2.5 lbs.

ROYALINE™ FLAGSTICKS

Ultra-strong, resilient, solid fiberglass construction. 1/2" diameter from top to bottom. Perfectly fit the ST2000 cups. 5' - 1 lbs.
7 1/2' - 1.5 lbs.

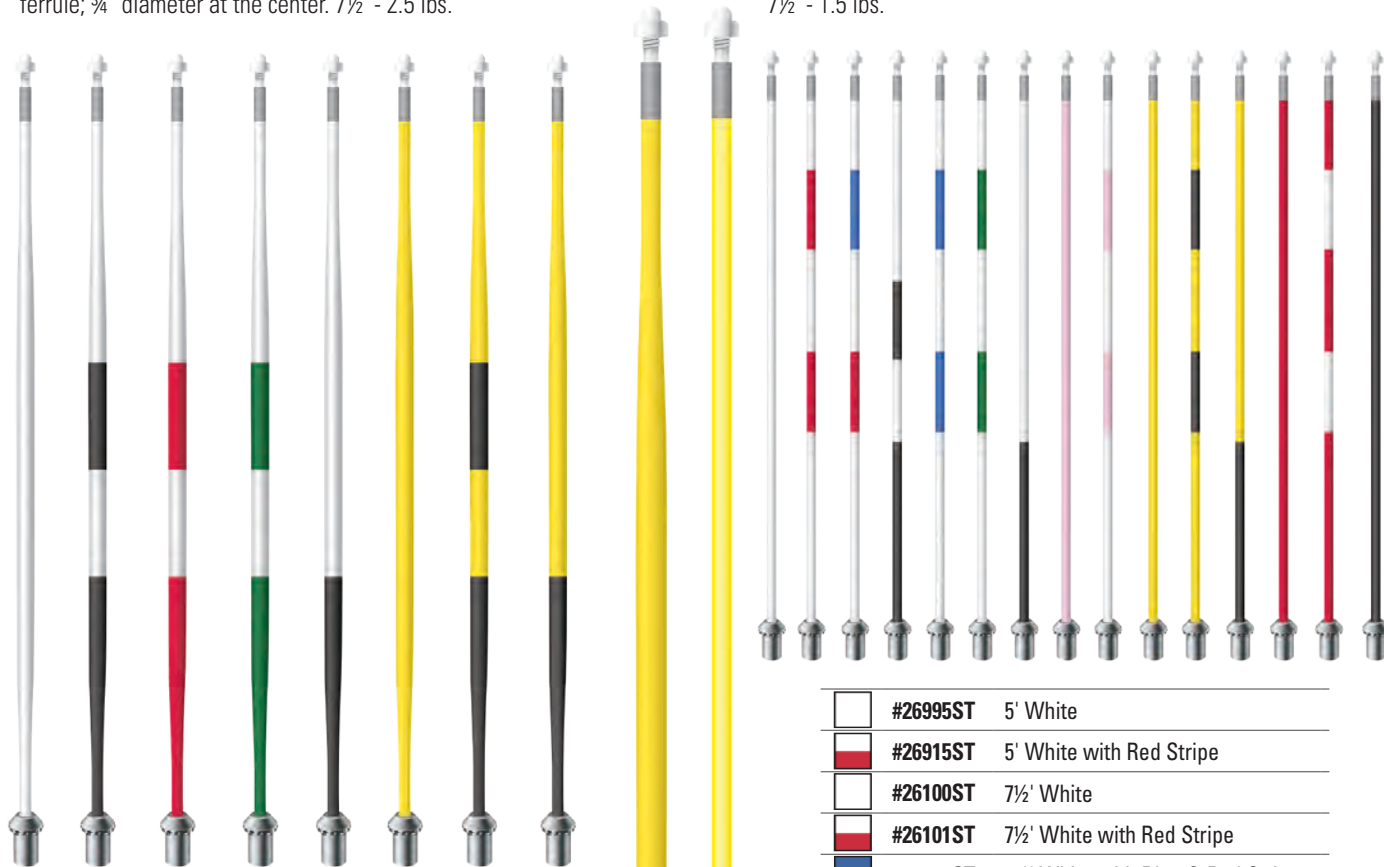

	#26300ST	7 1/2' White
	#26301ST	7 1/2' White with Black British Stripe
	#26302ST	7 1/2' White with Red British Stripe
	#26303ST	7 1/2' White with Green British Stripe
	#26304ST	7 1/2' White with 30" Black Bottom
	#26310ST	7 1/2' Yellow
	#26311ST	7 1/2' Yellow with Black British Stripe
	#26314ST	7 1/2' Yellow with 30" Black Bottom

	#26995ST	5' White
	#26915ST	5' White with Red Stripe
	#26100ST	7 1/2' White
	#26101ST	7 1/2' White with Red Stripe
	#26102ST	7 1/2' White with Blue & Red Stripe
	#26103ST	7 1/2' White with Black British Stripe
	#26104ST	7 1/2' White with Blue Stripe
	#26105ST	7 1/2' White with Green Stripe
	#26106ST	7 1/2' White with 30" Black Bottom
	#26107ST	7 1/2' White with Pink Stripe
	#26110ST	7 1/2' Yellow
	#26111ST	7 1/2' Yellow with Black Stripe
	#26112ST	7 1/2' Yellow with 30" Black Bottom
	#26120ST	7 1/2' Red
	#26121ST	7 1/2' Red with White Stripe
	#26130ST	7 1/2' Black

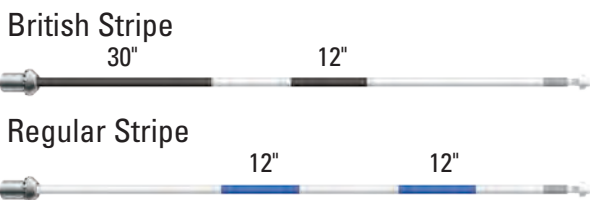

6" REGULATION GREEN CUPS

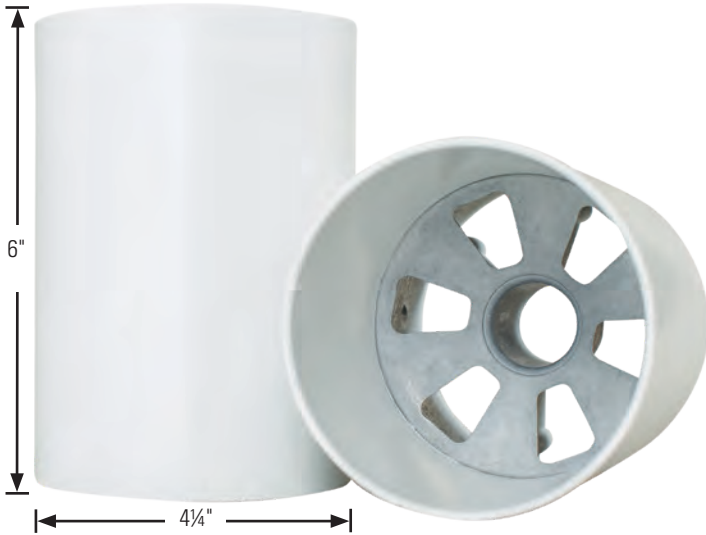

▶ ALUMINUM GREENS CUP

Unbeatable Chip-resistant finish. Six "feet" on bottom of cup eliminates sinking. Meets all USGA/R&A regulations. (1½ lbs.)

#18303ST

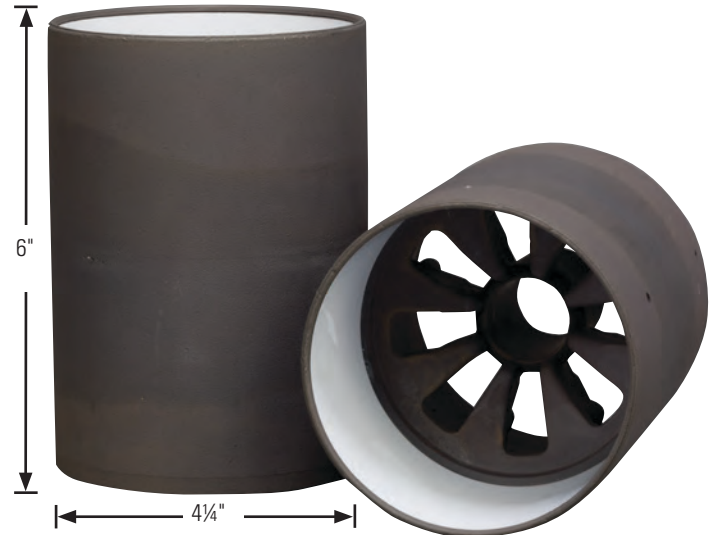

▶ ALUMINUM CUP WITH PLASTIC LINER

This cup combines the distinct sound of a ball landing in the aluminum cup, with the ease of replacing the plastic liner to keep your cup looking bright white.

Liner can be personalized with club logo for tournaments. (1½ lbs.)

#400117

REPLACEMENT SLEEVE

For aluminum 6" liner cup.

#40117-L

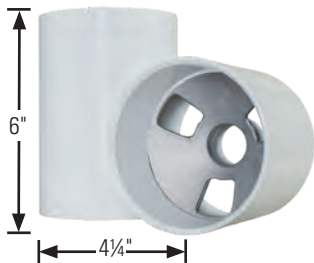

▶ 6" GREENS CUPS

Available in either molded chemical resistant plastic or anodized powder coated aluminum. Meets all USGA requirements.

#400100 - Aluminum (1½ lbs.)

#400104 - Plastic (½ lbs.)

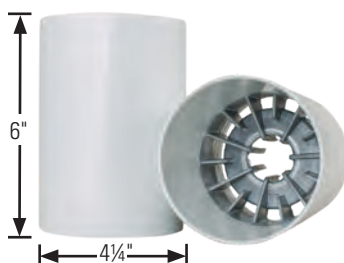

▶ ST2000 CUPS

Notched ferrule flag sticks easily fit into place every time. Available in either chemical resistant plastic or chip resistant Bondrite™ aluminum. Meets all USGA requirements.

#18333ST - Aluminum (1½ lbs.)

#18222ST - Plastic (1½ lbs.)

#18444ST - Hybrid (1 lbs.)



▶ PROLINE PLASTIC CUP

Ideal for less demanding conditions Brilliant White; finished with chemical-resistant polymers. Meets all USGA regulations.

#400867 (1½ lbs.)

See Page 61 For Putting Green 4" Cups

See your invoices/statements @ www.wittekgolf.com

PUTTING GREEN ACCESSORIES

▶ HOLE IN WHITE HOLE WHITENER SYSTEM

USGA approved, Hole in White is the most popular and the easiest way to paint the top of a cup. Simply press down and spin.

#400105 - Hole In White Tool

#400107 - Hole In White Paint

12 cans per case: Weight 13 lbs. 11" L x 8.5" W x 8.5" D



▶ SPEEDMETER

Made from extruded aluminum alloy with milled base to reduce bounce as the rolling ball makes contact with the green surface. Supplied complete with detailed instructions for an accurate measurement.

36" L x 2" W Weight 2 lbs.

#402205

▶ GREENS CUP ADVERTISING

An effective way to get your sponsors' name in front of customers. We can supply the transfers for you to apply, or we can supply the complete cups with graphics.

#S530



▶ HOLE TARGET RINGS

Bright white plastic Hole Target Rings sit just above the cup for added hole visibility. Easy insertion with most cup setters.

4" Diameter

#400861



PUTTING GREEN FLAGS 400 DENIER



6" x 9"



Similar in quality to our regulation flag, our practice greens flags are made of the highest quality, UV protected 400 denier nylon cloth that will resist fading even in the harshest conditions. 400 denier nylon is exceptionally strong and ideal for customizing. Logos can be added by silk screen method or embroidered. All flags are quadruple stitched on the trailing edges and triple cross stitched on the trailing corners to reduce the possibility of fraying.

TUBE LOCK Tube style flags are generally considered industry standard with a firm plastic tube sewn into one side of the flag that easily slips over all golf flag sticks.

SOFT POCKET Made using super strong canvas reinforcing. Top grommet in the handle area where tube usually goes. Flags can be washed with mild detergent. Easily fits all flag sticks

PLAIN FLAGS 400 DENIER

Color	Embroidered	Silk Screen	Plain
	Red #402071-E	Silk Screen #402071-S	Plain #402071
	White #402072-E	Silk Screen #402072-S	Plain #402072
	Yellow #402073-E	Silk Screen #402073-S	Plain #402073
	Blue #402074-E	Silk Screen #402074-S	Plain #402074
	Green #402075-E	Silk Screen #402075-S	Plain #402075
	Black #402076-E	Silk Screen #402076-S	Plain #402076
	Orange #402077-E	Silk Screen #402077-S	Plain #402077
	Gold #402079-E	Silk Screen #402079-S	Plain #402079



Please call for Soft Pocket Flags.

CUSTOM EMBROIDERED FLAGS 400 DENIER

Our unique embroidery process using the highest quality threads makes every flag a show piece. All embroidered flags are done in house ensuring the highest stitch count and for fast turn arounds.

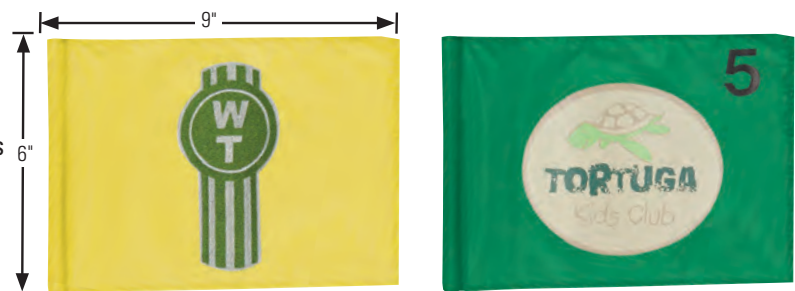

Order online 24/7 @ www.wittekgolf.com

GOLF COURSE ACCESSORIES

PUTTING GREEN FLAGS

6" x 9"

TUBE LOCK Tube style flags are generally considered industry standard with a firm plastic tube sewn into one side of the flag that easily slips over all golf flag sticks.

SOFT POCKET Made using super strong canvas reinforcing. Top grommet in the handle area where tube usually goes. Flags can be washed with mild detergent. Easily fits all flag sticks

CHECKERED PUTTING FLAGS 400 DENIER

Checkered Flags

- #402080 -  Black / Yellow Checks
- #402082 -  Black / White Checks
- #402083 -  Blue / White Checks
- #402084 -  Green / White Checks
- #402085 -  Red / White Checks

Additional colors available
Please call for details

Please call for Soft Pocket Flags.

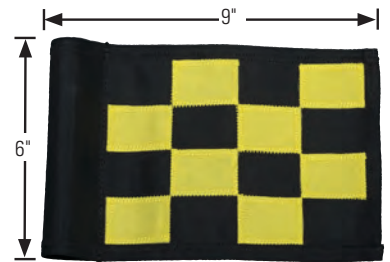

NUMBERED PUTTING FLAGS 400 DENIER

Sold In Sets
Of 9 Only.

Color	Tube Lock 1-9	Tube Lock 10-18	Soft Pocket 1-9	Soft Pocket 10-18
White / Black Numbers	#401458	#401459	#401558	#401559
Blue / White Numbers	#401456	#401457	#401556	#401557
Red / White Numbers	#401450	#401451	#401550	#401551
Yellow / Black Numbers	#401452	#401453	#401552	#401553

Additional colors available. Please call for details

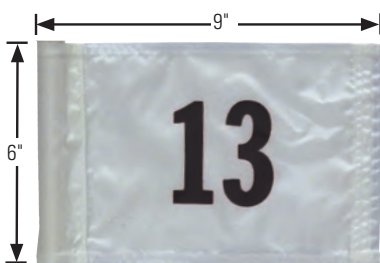

PRACTICE GREEN MARKERS

▶ PUTTING GREEN MARKERS

Classic putting green marker fits perfectly into any regulation golf cup. Fiberglass rod with a plastic base on the bottom. Weight .50 lbs.

#400450	White
#400451	White with Black Stripes
#400452	White with Blue Stripes
#400453	White with Green Stripes
#400454	White with Red Stripes
#400455	Yellow
#400456	Yellow with Black Stripes

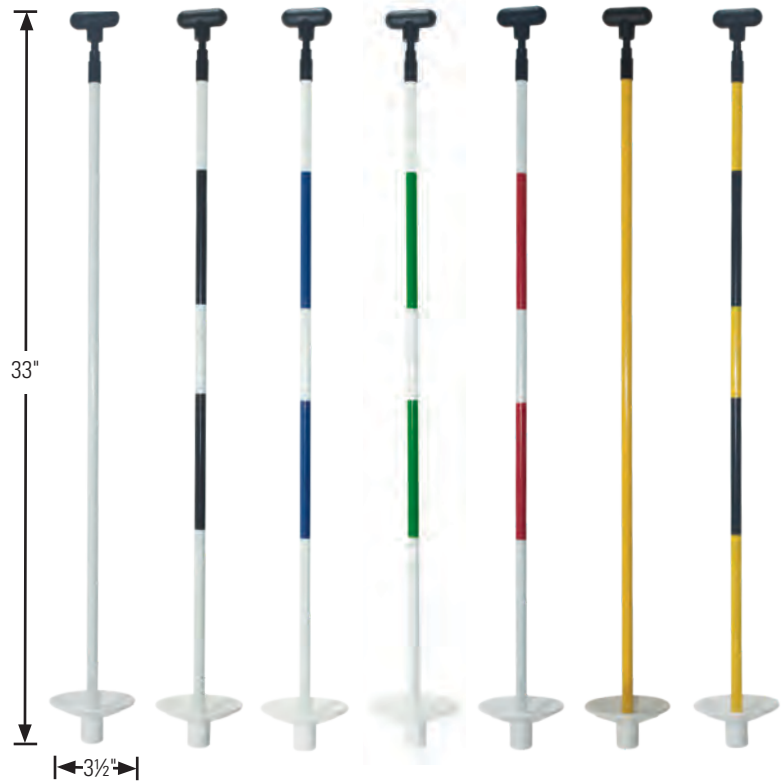

4" PRACTICE GREEN CUPS

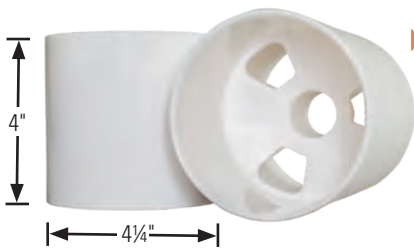

▶ **PLASTIC PUTTING GREEN CUP**
Molded from durable chemical-resistant polymers.
#400108 (.3 lbs.)

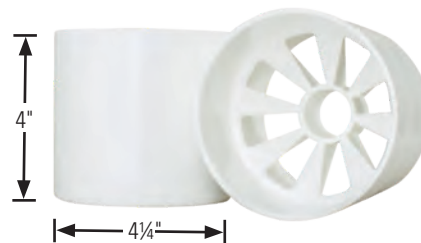

▶ **PLASTIC PRACTICE GREEN CUP**
Features molded plastic construction and reinforced webs.
#400865 (.3 lbs.)

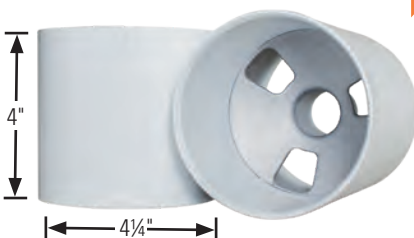

▶ **ALUMINUM PRACTICE GREEN CUP**
Aluminum cup is anodized then powder coated a bright white. High wear area is dark gray to keep cups looking good and reduces maintenance.
#400103 (1 lb.)

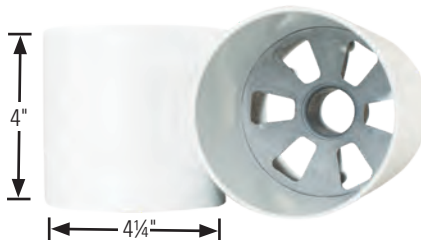

▶ **ALUMINUM PRACTICE GREEN CUP**
Bonderite™ Aluminum for the most chip-resistant coating. Beveled bottom edge makes cups easier to insert and remove.
#18150ST (1 lb.)

Check your order history @ www.wittekgolf.com

PRACTICE GREEN FLAGSTICKS

▶ PRACTICE GREEN ROD

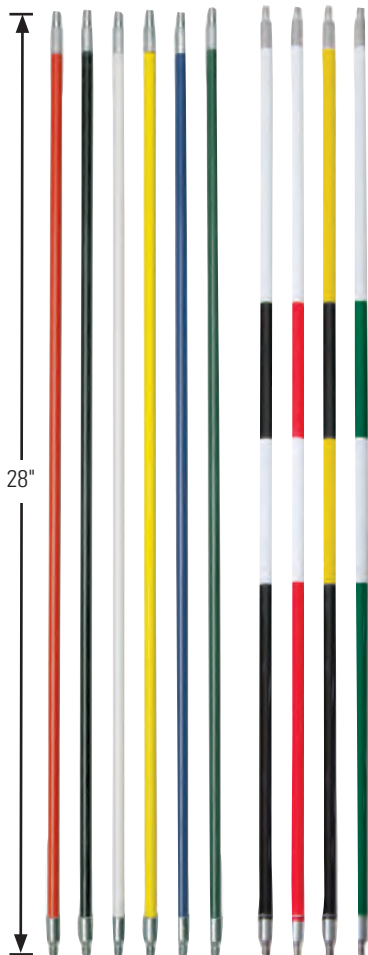

28"

**FITS LARGE TUBE
PRACTICE GREEN FLAGS**



▶ **PLASTIC BASE**
#400409

- Solid, resilient fiberglass construction
- $\frac{3}{8}$ " (1cm) diameter; 28" (71 cm) long
- Knob and base sold separately

SOLID ROD ONLY

	Red	#20182ST
	Black	#20282ST
	White	#20382ST
	Yellow	#20482ST
	Blue	#20582ST
	Green	#20682ST

STRIPED ROD ONLY

	Black/White	#20010ST
	White/Red	#20020ST
	Yellow/Black	#20030ST
	Green/White	#20040ST



▶ **SOLID METAL BASE**
4 $\frac{1}{4}$ " H x 2 $\frac{1}{4}$ " W
#402370



▶ KNOB FOR PRACTICE GREEN ROD

#402371 - Marker Knob (.2 lbs.)

#402372 - Jr Tournament (.3 lbs.)

▶ JR. TOURNAMENT PRACTICE ROD

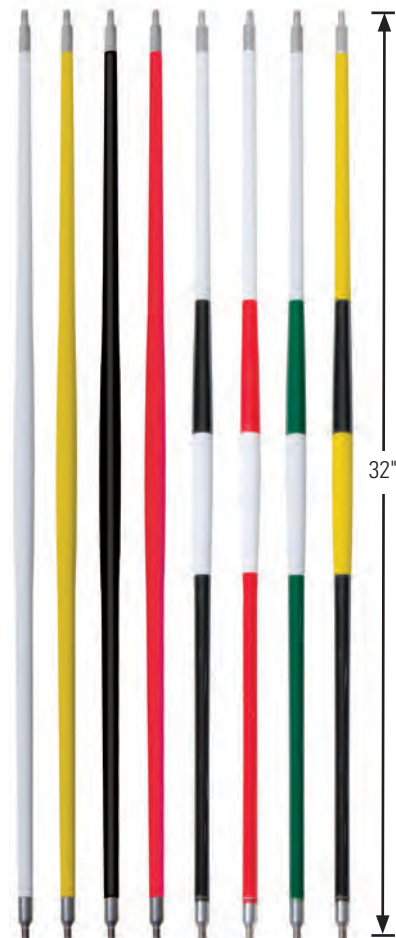

32"

- New lighter, more flexible material allows for a longer lifetime and durability
- $\frac{1}{2}$ " (1.3 cm) diameter tip and furrule leads to a $\frac{3}{4}$ " (1.9 cm) center; 32" (81 cm) long
- Fits $\frac{1}{2}$ " (1.3 cm) practice green flags only
- Knob and base sold separately

SOLID ROD ONLY

	White	#20200ST
	Yellow	#20225ST
	Black	#20227ST
	Red	#20228ST

STRIPED ROD ONLY

	Black/White	#20201ST
	Red/White	#20202ST
	Green/White	#20203ST
	Black/Yellow	#20204ST

PRACTICE GREEN MARKERS

▶ CAST ALUMINUM PRACTICE GREEN MARKERS

- The resiliency and functionality of cast aluminum.
- Plain or personalized with sets of numbered decals or your club logo.
- Fits 3/8" rods only.



- #20537ST - Black Aluminum Head Only
- #20536ST - Blue Aluminum Head Only
- #20535ST - Green Aluminum Head Only
- #20534ST - Red Aluminum Head Only
- #20532ST - White Aluminum Head Only
- #20533ST - Yellow Aluminum Head Only

▶ PRACTICE GREEN MARKER DECALS

Color	#1-9	#10-18
Black	#402380	#402381
Blue	#402382	#402383
Red	#402384	#402385
White	#402386	#402387
Yellow	#402388	#402389



- *Sold as a Set of 2*
- #20511ST - 36 Personalized Decals
- #20512ST - 54 Personalized Decals
- #20513ST - 72 Personalized Decals
- #20514ST - 108 Personalized Decals
- #20515ST - 144 Personalized Decals
- #20516ST - 216 Personalized Decals
- #402009 - Art Charge .

▶ NUMBERED PRACTICE GREEN PENNANT SETS

- Classic, one-piece plastic head and fiberglass rod combinations.
- Order them in single units (one plastic head, rod and base) or as a set (nine units).

Rod; 1 3/8" (1cm) diameter; 28" (71 cm) long	Flag Only	Single Unit with rod and base	Set 1-9 with rod and base	Set 10-18 with rod and base
White Head/Red Rod	#20393ST	#20392ST	#20391ST	#20390ST
White Head/Green Rod	#20493ST	#20492ST	#20491ST	#20490ST
Black Head/Yellow Rod	#20593ST	#20592ST	#20591ST	#20590ST



*Specify hole numbers when ordering single flags.

▶ CUSTOM PUTTING MARKER HEADS

Custom heads made from highly durable laminated plastic are alternatives to using putting flags.



Chat with specialists @ www.wittekgolf.com

LAMINATE DIRECTIONAL SIGNS

Easy to read, long-lasting laminate signs are available in 2 popular standard colors. All signs can be single-sided or double-sided. Complete with two 5" steel spikes. For custom wording, colors and languages, please call.

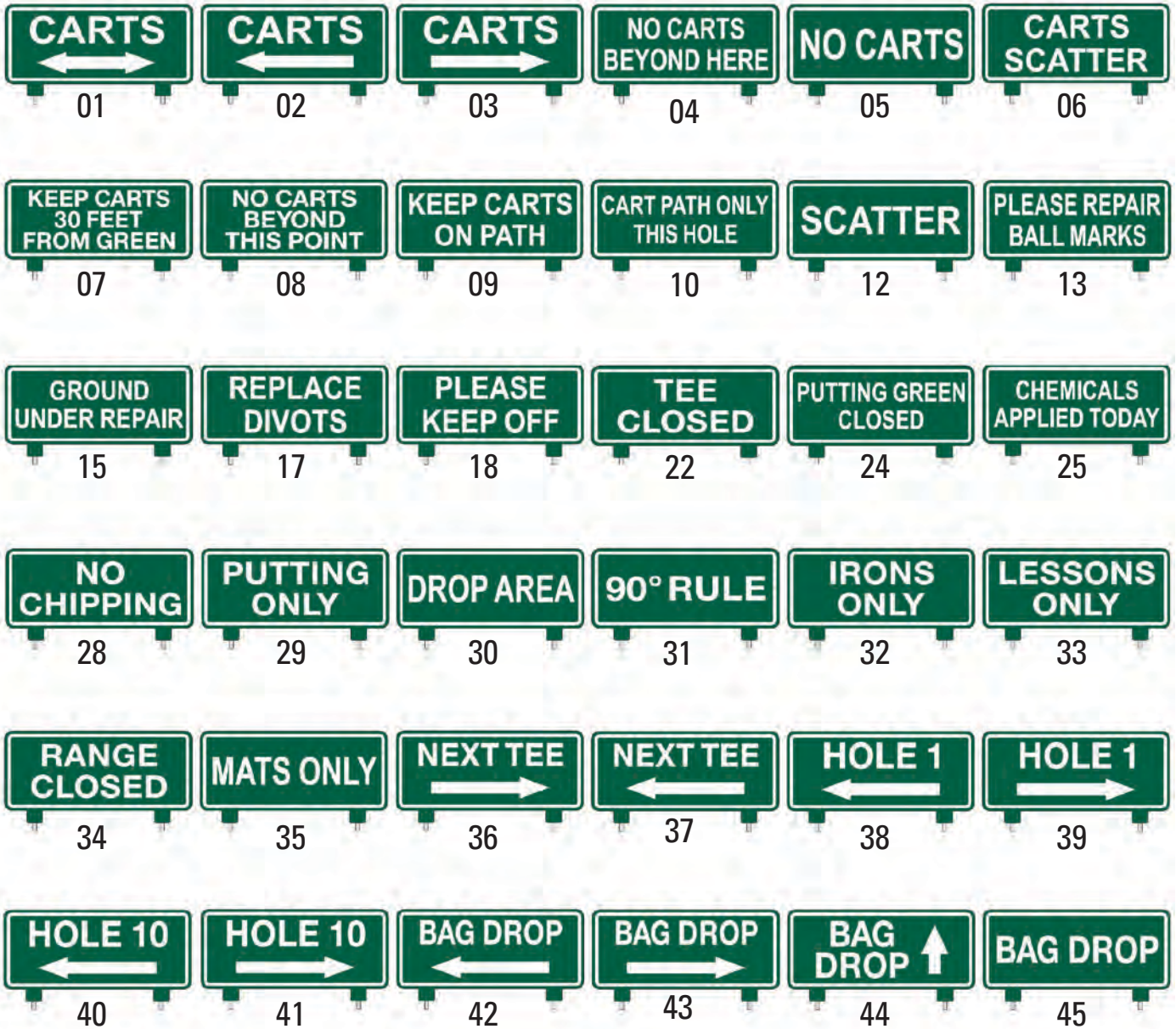

No. of Sides	Size	Green/White	Yellow/Black
Single-Sided	12" W x 6" H (1.75 lbs.)	#405880	#405882
Double-Sided	12" W x 6" H (1.75 lbs.)	#405883	#405885
Single-Sided	15" W x 9" H (3.5 lbs.)	#405886	#405888
Double-Sided	15" W x 9" H (3.5 lbs.)	#405889	#405891

Example: Green/White Single Sided 12" x 6" - No Carts - 405880-05

ALUMINUM DIRECTIONAL SIGNS

- 10" x 6" sign face, 1/8" thick.
- Durable, powder coated finish out-performs conventional paint.
- Easily customized with your message.
- Double-sided signs with arrows have the direction reversed on the 'back'.
- Other color combinations and languages available - call for details.

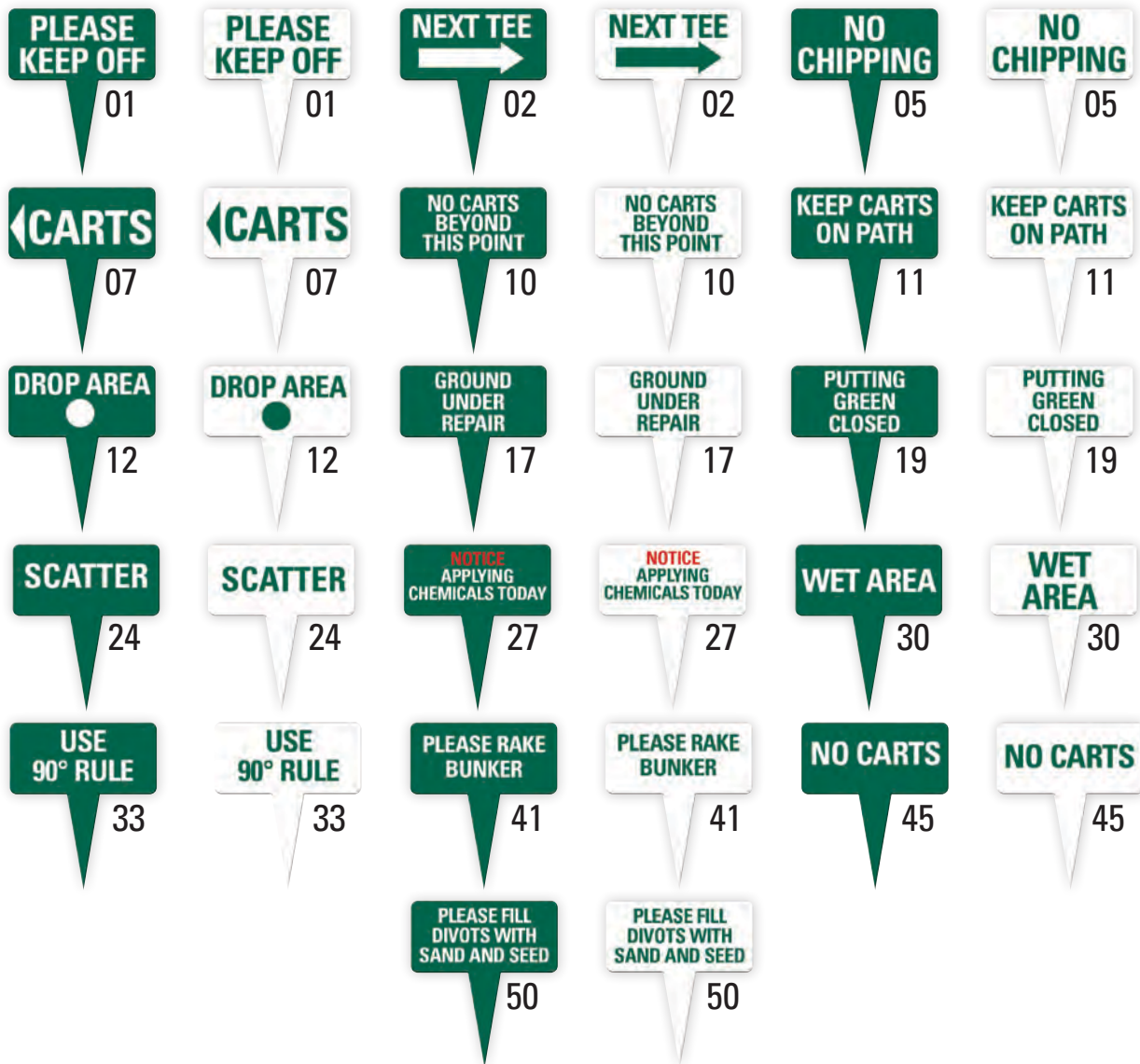

Color	Size	
Green Sign,White Letters	10" W x 6" H (.65 lbs.)	#405893
White Sign,Green Letters	10" W x 6" H (.65 lbs.)	#405892

Example: Green/White 10 x 6" - Next Tee - 405893-02

Reorder easily @ www.wittekgolf.com

CUSTOM TEE & INFORMATION SIGNS

- Stylish. Low maintenance. 3/4" laminate weather-resistant signs.
- Tee signs can include club logo, hole number, par, yardage with optional hole layout.
- Sign can be pre-drilled for easy installation.
Please specify if you do want the signs drilled when ordering.
- Mounting Post sold separately.

ORDERING IS AS EASY AS 1-2-3

#1 Size & Shape

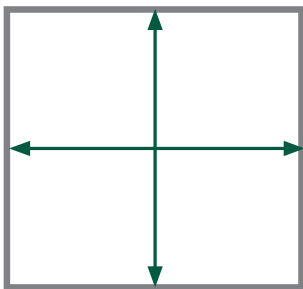

Popular Sizes

- 12 x 18
- 14 x 20
- 18 x 24



#2 Hole number, Par, Tee w/Distance, # Tees, Layout, Material, Lexan or Engraved



Sample With Layout
#405004

Sample Without Layout
#405005

#3 Custom Logo & Mounting Post



POSTS

The perfect mounting option for our Tee Signs, our 4" x 4" recycled plastic posts feature a decorative beveled top.

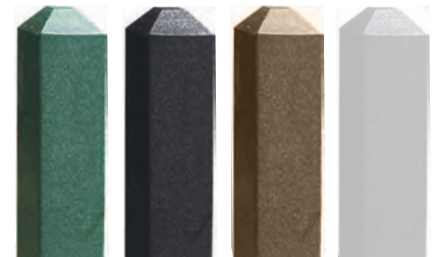

Length	Green	Black	Brown	White
4 Ft	#405050-4	#405051-4	#405052-4	#405053-4
5 Ft	#405050-5	#405051-5	#405052-5	#405053-5
6 Ft	#405050-6	#405051-6	#405052-6	#405053-6
7 Ft	#405050-7	#405051-7	#405052-7	#405053-7
8 Ft	#405050-8	#405051-8	#405052-8	#405053-8

A FRAME SIGNS

These dual color A-frame signs are made of a durable, stain resistant, 1/2" laminated sign board. Messages can be engraved to highlight core color or color filled for your preferred font appearance.

Other features include a handsome engraved outline running along the outer edges of this sign allowing it to "pop" and a convenient handle near the top.



CUSTOM SIGNS

Our sign department has over 20 years of experience in the design and manufacturing of many different types of golf course and clubhouse signage.

All work is done in house with our focus on long lasting, low maintenance signs that will look great for years. No matter what type of message you need to convey - from large entryway signs to small directional signs, our design and manufacturing team can make it happen.



NEED IT QUICKLY? FAST TURN AROUNDS ARE OUR SPECIALTY!

Call for custom quotes

See your invoices/statements @ www.wittekgolf.com

GOLF COURSE ACCESSORIES

CUSTOM TEE & INFORMATION SIGNS

SOLID BRONZE & ALUMINUM



SIGNATURE

SHOWN IN: POLISHED BRONZE



CLASSIC

SHOWN IN: POLISHED ALUMINUM



IMPERIAL

SHOWN IN: ALUMINUM WITH ROLLED GOLD

#405016 - Custom Cast Aluminum Tee Sign

#405017 - Custom Bronze Tee Sign

#405018 - Custom Cast Aluminum Information Sign

#405019 - Custom Cast Bronze Information Sign

IN-GROUNDS



SQUARE



CIRCLE



RECTANGLE



OVAL

TEE MARKERS



#405030 - Custom Metal Tee Markers



CUSTOM OPTIONS AVAILABLE

ASK ABOUT OUR FULL LINE OF CAST METAL SIGNAGE & MARKERS

GOLF COURSE ACCESSORIES

FUSION CAST SIGNS

ENGINEERED METAL

▶ TEE SIGN



Size	Materials
12" x 18"	Aluminum
14" x 20"	Bronze/Copper"
16" x 22"	
18" x 24"	



Cast Hole Layout



Domed Hole Layout

*Custom shapes & sizes available. Contact us for more info.

▶ IN-GROUND MARKERS



▶ CUSTOM SIGN & TEE MARKERS



Circular without Logo	
Size	Materials
6" x 6"	Aluminum
8" x 8"	Bronze/Copper
10" x 10"	

Rectangular & Oval without Logo	
Size	Materials
6" x 6"	Aluminum
8" x 8"	Bronze/Copper
10" x 10"	

Circular with Logo	
Size	Materials
6" x 6"	Aluminum
8" x 8"	Bronze/Copper
10" x 10"	

Rectangular & Oval with Logo	
Size	Materials
6" x 6"	Aluminum
8" x 8"	Bronze/Copper
10" x 10"	

Use your terms @ www.wittekgolf.com

ALUMINUM INFORMATIONAL SIGNS

- Single-sided.
 - Order Sign Posts separately
 - Weather- Resistant Ink
- Call to Discuss Custom Signage



#406367



#406363



#406368



#406369



#406373



#406370



#406372



#406371



Rattlesnakes
#407040 - 12" X 12"



Alligators/ Rattlesnakes
#407041 - 12" X 12"



#406377 - Wisconsin -

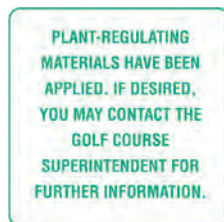

#406376 - Kentucky -

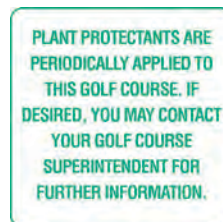

#406375 - Illinois -



Recycled Products
#407044 - 12" X 12"



Today's Turf Schedule
#407051 - 24" X 18"



Cart Crossing
#407011 - 18"
#407012 - 24"

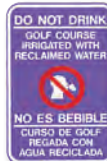

Don't Drink The Water
#407049 - 12" X 18"



Caution Speed Bumps
#407013 - 12"
#407014 - 24"



#407001 - Stop 12"
#407002 - Stop 18"
#407003 - Stop 24"



Handicap Parking Only
#407020 - 12" X 18"

CUSTOM TEE MARKERS

▶ MOLDED TEE MARKERS

Are you looking for your logo to come to life on the tee box? Our expert design staff has years of experience and can create just what you are looking for. Made of super strong epoxy resins, molded tee markers can be easily colored or highlighted to indicate various tee locations. **Call today to discuss the many options available.**



▶ LAMINATED TEE MARKERS



Order online 24/7 @ www.wittekgolf.com

TEE MARKERS

▶ ANGLED LOG TEE MARKERS

4 ¼" H x 4"W with 3 ½" spike (3.6 lbs.).



- #406804 - ■ Black
- #406802 - ■ Blue
- #406800 - ■ Red
- #406801 - □ White
- #406803 - ■ Yellow
- #406805 - ■ Green

▶ SLIM LIMB TEE MARKERS

These attractive three dimensional tee markers are molded from extremely strong and durable resins. Two spikes in each marker to keep them lined up the right way. 9" Long, 2" Wide, 2 ½" High (1.5 lbs.).

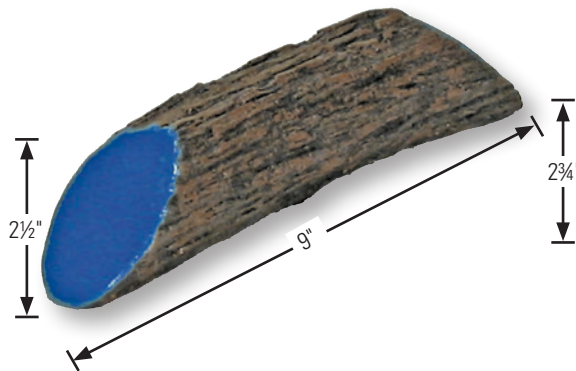

- #T009109BLK - ■ Black
- #T009109B - ■ Blue
- #T009109R - ■ Red
- #T009109W - □ White
- #T009109Y - ■ Yellow
- #T009109G - ■ Green

▶ LOG TEE MARKERS

These attractive three dimensional tee markers are molded from extremely strong and durable resins. Two spikes in each marker to keep them lined up the right way. 7 ¾" Long, 3 ½" Wide, 2 ¾" High (1.85 lbs.).

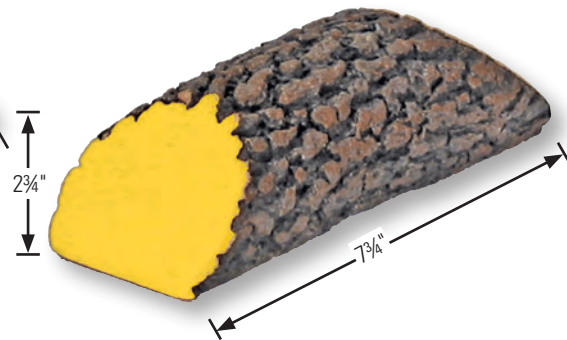

- #T001BLK - ■ Black
- #T001B - ■ Blue
- #T001R - ■ Red
- #T001W - □ White
- #T001Y - ■ Yellow
- #T001G - ■ Green

Ask us how you can personalize log tee markers with custom colors or your course's logo.

BROKEN TEE CADDIES

▶ BROKEN TEE BASKET

- One Piece Construction
- Weather Resistant
- Non-Toxic to Plants & Soil
- Nests for easy storage (.5 lbs.)

#405219 - Green Only
(Box of 18)



▶ BROKEN TEE CADDIE

- Sleek cone-shape design minimizes footprint.
- Powder-coated steel construction.
- Includes "Broken Tee" decal and 5" spike. 6"H (1 lbs.)

- #19000ST - ■ Black
- #19015ST - ■ Yellow
- #19025ST - ■ Red
- #19050ST - ■ Green
- #19075ST - ■ Blue
- #19085ST - ■ Orange
- #19095ST - □ White



▶ BROKEN TEE BOX

Made from durable maintenance free recycled plastic. Sure to keep your tee boxes clean and mower blades sharp. Drainage allows for sand and water to sift through the bottom. Size: 6 ½"W x 8 ¼"L (1 ½ lbs.).

- #405215 - Green
- #405216 - Brown
- #405217 - Black

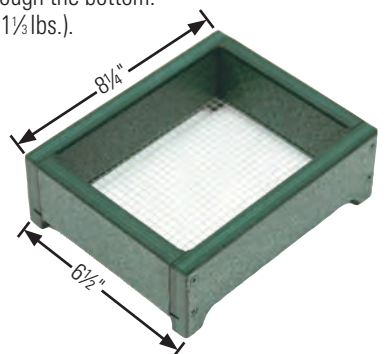

▶ **CUBE TEE MARKER**

- Simple square cube makes an attractive angular marker design.
- 100% recycled material.
- 3½"H x 3½"W with 4"spike (1.11 lbs.).

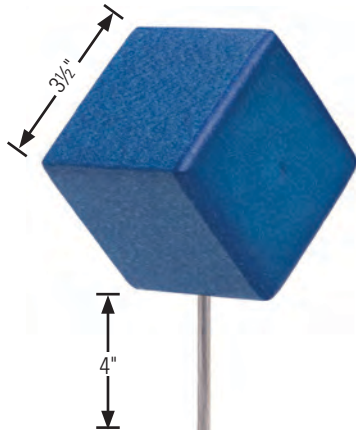

- #405260 - Black
- #405261 - Blue
- #405262 - Brown
- #405263 - Green
- #405264 - Red
- #405265 - White
- #405266 - Yellow

▶ **Double-Stack Tee Marker**

- Stacked, high-profile beveled tower design enhances any tee area.
- 100% recycled material.
- 6"H x 4"W with 4"spike (1.72 lbs.).

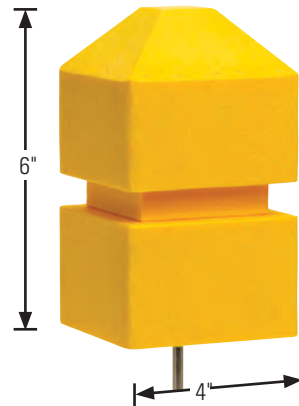

- #405250 - Black
- #405251 - Blue
- #405252 - Brown
- #405253 - Green
- #405254 - Red
- #405255 - White
- #405256 - Yellow

▶ **BALL TEE MARKER**

These durable tee markers are made to last and look great for many seasons. They are also easily refurbished to look like new. Made from a special formula resin, these tee markers look and feel similar to a billiard ball. Logo's can be added - call for details.

Color	3"	3" w/ Neck	4"	4" w/ Neck	5"	5" w/ Neck
Black	#400130	#400140	#400150	#400160	#400170	#400180
Blue	#400131	#400141	#400151	#400161	#400171	#400181
Gray	#400132	#400142	#400152	#400162	#400172	#400182
Green	#400133	#400143	#400153	#400163	#400173	#400183
Marigold	#400134	#400144	#400154	#400164	#400174	#400184
Red	#400135	#400145	#400155	#400165	#400175	#400185
White	#400136	#400146	#400156	#400166	#400176	#400186
Yellow	#400137	#400147	#400157	#400167	#400177	#400187



▶ **CLASSIC-T MARKER**

- One-piece, easy-to-handle design.
- Economical option, built to last.
- 3½" D with 3"spike (1 lbs.).

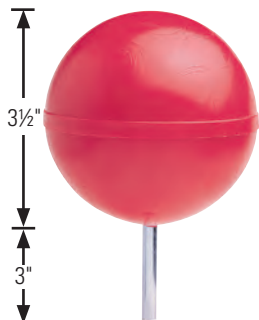

- #5600ST - Red
- #5601ST - White
- #5602ST - Blue
- #5603ST - Yellow
- #5605ST - Black
- #5608ST - Orange
- #5609ST - Green

▶ **PLAIN DIMPLE-T MARKER**

- The original. Most durable ever built.
- Favorite of golf courses worldwide.
- 5"D with 4½"spike (1 lbs.).



- #5250ST - Red
- #5251ST - White
- #5252ST - Blue
- #5253ST - Yellow
- #5255ST - Black
- #5256ST - Silver
- #5257ST - Gold
- #5258ST - Orange
- #5259ST - Green

▶ **PERSONALIZED DIMPLE-T MARKER**

- Personalize the classic Dimple-T Marker with your club logo.
- Decals priced separately.
- 5"D with 4½"spike (1 lbs.).



- #5270ST - Red
- #5271ST - White
- #5272ST - Blue
- #5273ST - Yellow
- #5275ST - Black
- #5276ST - Silver
- #5277ST - Gold
- #5278ST - Orange
- #5279ST - Green

Check your order history @ www.wittekgolf.com

SCRUSHER[®] & DELUXE SCRUSHER[®]

- Three separate bottom brushes now with softer, longer-lasting nylon bristles.
- Two side brushes with gentler bristles that don't scratch the sides of shoes.
- The wider design of the Deluxe Scrusher[®] offers more stability and extra space between lower bristles to prevent buildup.
- Durable cast aluminum, powder-coated base included on the Deluxe model.
- Mounting stakes sold separately, four per unit.
6½"H x 22¼"L x 6"D

#14100ST	Scrusher Spike Brush
#14000ST	Deluxe Scrusher Spike Brush
#14050ST	Deluxe Scrusher Handle
#14102ST	Scrusher Bottom Brush (3 needed)
#14103ST	Scrusher Side Brush (2 needed)
#14106ST	6" Asphalt Mounting Stake (4 needed)
#14124ST	18" Turf Mounting Stake (4 needed)

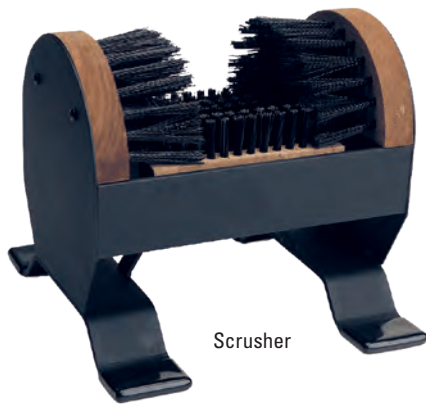

Scrusher



Deluxe Scrusher

SPIKE CLEANERS

▶ SPIKE BRUSH

Efficient synthetic bristles with a durable, cast aluminum, powder-coated base. Includes four 3½" stakes.

5¾" W x 5½" L (1.3 lbs.).

- #14750ST - Black
- #14450ST - Green
- #14350ST - Red
- #14252ST - Replacement Spike Brush



▶ RECYCLED PLASTIC SPIKE BRUSH

Made from low maintenance recycled plastic, this brush can either bolt down to solid surfaces or spike into grass. 5¾" W x 5¼" L

- #C011 - Complete Spike Brush Unit
- #C008 - Replacement Base Brush
- #C009 - Replacement Side Brush
(2 required if replacing both sides)



▶ DUO-KLEENER™ SPIKE BRUSH STAND

- Put this useful spike cleaner to work wherever it's needed most.
- Anchors in asphalt or in the ground with turf stakes.
- Includes stand, brushes, hardware and three 3½" spikes (17.6 lbs.).

#36650ST



▶ SPIKE BRUSH WITH CONSOLE MOUNT

#36156BST



▶ SPIKE BRUSH WITH VERTICAL POST MOUNT

#402412



NEET KLEET ELECTRIC SPIKE CLEANER

- Molded plastic body eliminates unsightly paint chipping, fading and rusting common to other shoe cleaners!
- Dual handles provide a stable platform while cleaning golf shoes.
- Push button in handle activates machine from 110V outlet.
- All debris is captured in the removable grass receptacle for daily maintenance.
- Rotating nylon brushes clean sides, soles, heels and toes.
- Nylon Brush suitable for steel or alternative spikes.
- Weight: 38 lbs., Size: 32"L x 15½"W x 32"H

#WGL70G - Green

#WGL70T - Tan

**Also available in 220V units.

#WG019S - Replacement Brush Set
(3 Brushes)

#WG065 - Replacement Motor

#WG050 - Replacement Belt

#WGL70-P10 - Push Button Switch



RANGE EQUIPMENT

RANGE SUPPLIES

GOLF COURSE ACCESSORIES

COMPRESSED AIR SPIKE CLEANER



This console offers convenient spike cleaning while keeping your facility neat and tidy. Made from durable recycled plastic lumber, it is used with compressed air to clean the bottom of the golfers' shoes. Clippings are contained by the high wrap around walls and a 90 degree wand allows easy cleaning without uncomfortable bending by the golfer. Contained clippings fall through a bottom grate into a removable tray for easy disposal. Each unit comes with Deluxe 20' Long Air Blow Gun. Air compressor sold separately.

Weight: 80 lbs. Size: 32"L x 19"W x 40"H

#CO55-G - Green

#CO55-BRN - Brown

#CO55-BLK - Black

#CO55-DRT - Driftwood

#CO55-WN - Walnut

Logo's can be included on the side or front of this unit. Please speak to one of our sales professionals.

Color choices for all recycled plastic products

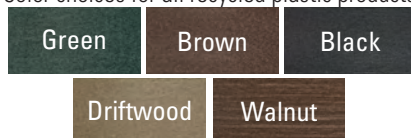

IRRIGATION & MAINTENANCE

PRO SHOP ACCESSORIES

MINI GOLF

Chat with specialists @ www.wittekgolf.com

ROPE AND CHAIN STAKES 2" X 2"

Maintenance free and made with recycled material.

Available in a variety of sizes and designs to fit your needs.

▶ BASIC

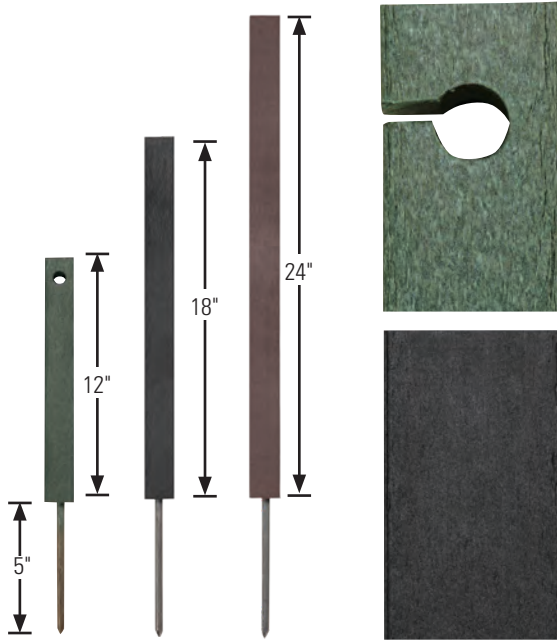

Basic - Standard Colors

	12"	18"	24"
Green - Hole	#405600-1B	#405601-1B	#405602-1B
Green - Speed Slot	#405600-1C	#405601-1C	#405602-1C
Black - Hole	#405610-1B	#405611-1B	#405612-1B
Black - Speed Slot	#405610-1C	#405611-1C	#405612-1C
Brown - Hole	#405620-1B	#405621-1B	#405622-1B
Brown - Speed Slot	#405620-1C	#405621-1C	#405622-1C

Basic - Premium Colors

	12"	18"	24"
Walnut - Hole	#405630-1B	#405631-1B	#405632-1B
Walnut - Speed Slot	#405630-1C	#405631-1C	#405632-1C

▶ TRADITIONAL

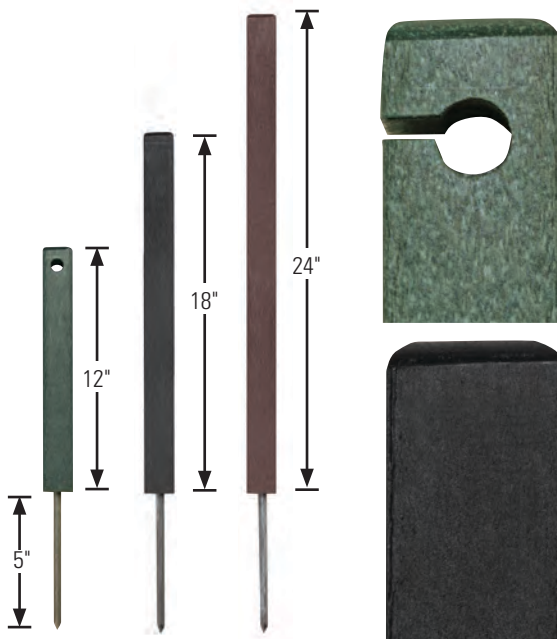

Traditional - Standard Colors

	12"	18"	24"
Green - Hole	#405600-2B	#405601-2B	#405602-2B
Green - Speed Slot	#405600-2C	#405601-2C	#405602-2C
Black - Hole	#405610-2B	#405611-2B	#405612-2B
Black - Speed Slot	#405610-2C	#405611-2C	#405612-2C
Brown - Hole	#405620-2B	#405621-2B	#405622-2B
Brown - Speed Slot	#405620-2C	#405621-2C	#405622-2C

Traditional - Premium Colors

	12"	18"	24"
Walnut - Hole	#405630-2B	#405631-2B	#405632-2B
Walnut - Speed Slot	#405630-2C	#405631-2C	#405632-2C

Beveled - Standard Colors

	12"	18"	24"
Green - Hole	#405600-3B	#405601-3B	#405602-3B
Green - Speed Slot	#405600-3C	#405601-3C	#405602-3C
Black - Hole	#405610-3B	#405611-3B	#405612-3B
Black - Speed Slot	#405610-3C	#405611-3C	#405612-3C
Brown - Hole	#405620-3B	#405621-3B	#405622-3B
Brown - Speed Slot	#405620-3C	#405621-3C	#405622-3C

Beveled - Premium Colors

	12"	18"	24"
Walnut - Hole	#405630-3B	#405631-3B	#405632-3B
Walnut - Speed Slot	#405630-3C	#405631-3C	#405632-3C

Empire - Standard Colors

	12"	18"	24"
Green - Hole	#405600-4B	#405601-4B	#405602-4B
Green - Speed Slot	#405600-4C	#405601-4C	#405602-4C
Black - Hole	#405610-4B	#405611-4B	#405612-4B
Black - Speed Slot	#405610-4C	#405611-4C	#405612-4C
Brown - Hole	#405620-4B	#405621-4B	#405622-4B
Brown - Speed Slot	#405620-4C	#405621-4C	#405622-4C

Empire - Premium Colors

	12"	18"	24"
Walnut - Hole	#405630-4B	#405631-4B	#405632-4B
Walnut - Speed Slot	#405630-4C	#405631-4C	#405632-4C

▶ BEVELED

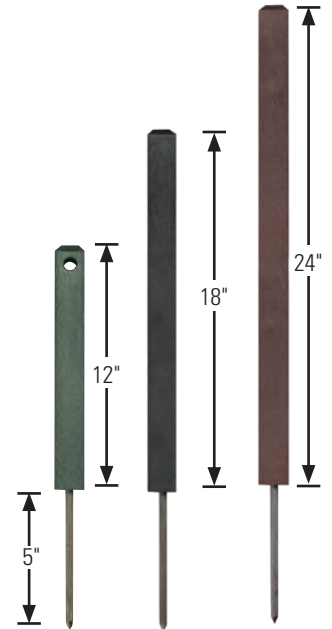

▶ EMPIRE

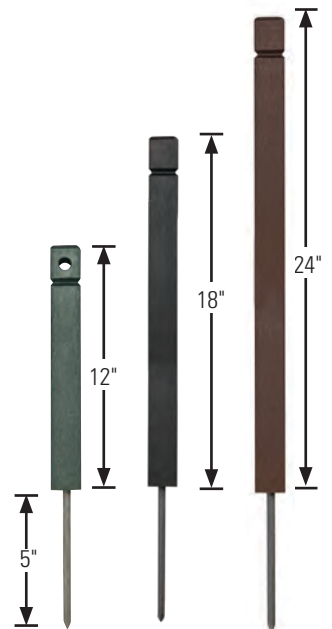

HAZARD AND OB STAKES 2" X 2"

Maintenance free and made with recycled material.

Available in a variety of sizes and designs to fit your needs.

▶ BASIC

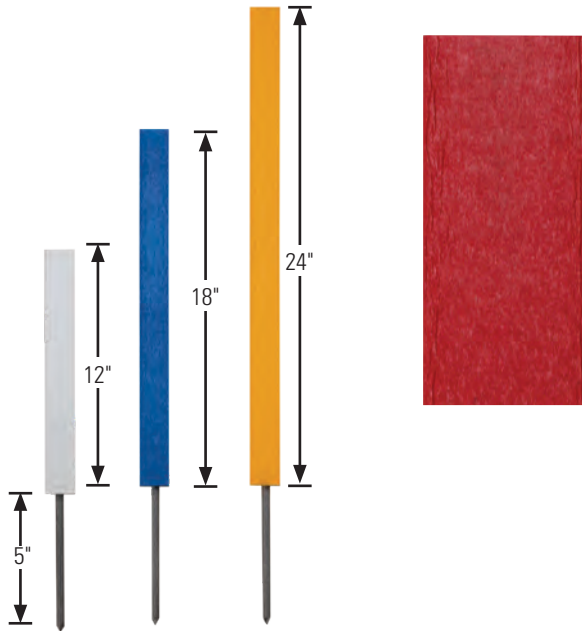

Basic

	12"	18"	24"
Yellow	#405635-1	#405636-1	#405637-1
Red	#405640-1	#405641-1	#405642-1
White	#405645-1	#405646-1	#405647-1
Blue	#405650-1	#405651-1	#405652-1

▶ TRADITIONAL

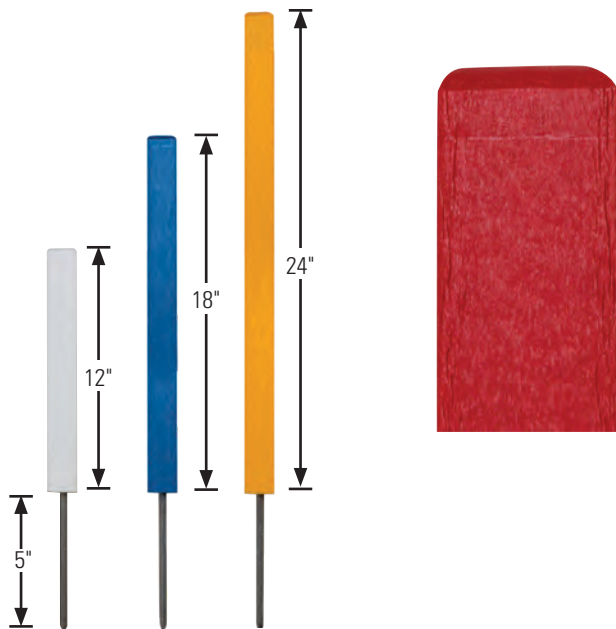

Traditional

	12"	18"	24"
Yellow	#405635-2	#405636-2	#405637-2
Red	#405640-2	#405641-2	#405642-2
White	#405645-2	#405646-2	#405647-2
Blue	#405650-2	#405651-2	#405652-2

▶ BEVELED

Beveled

	12"	18"	24"
Yellow	#405635-3	#405636-3	#405637-3
Red	#405640-3	#405641-3	#405642-3
White	#405645-3	#405646-3	#405647-3
Blue	#405650-3	#405651-3	#405652-3

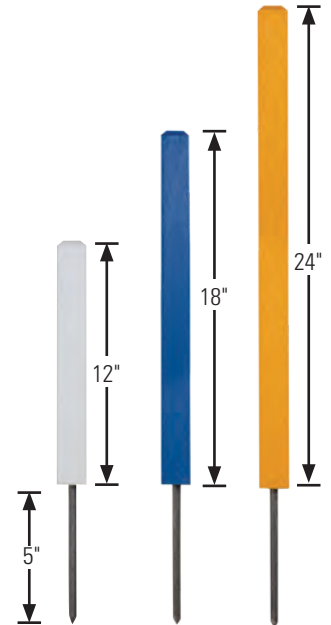

Empire

	12"	18"	24"
Yellow	#405635-4	#405636-4	#405637-4
Red	#405640-4	#405641-4	#405642-4
White	#405645-4	#405646-4	#405647-4
Blue	#405650-4	#405651-4	#405652-4



▶ EMPIRE

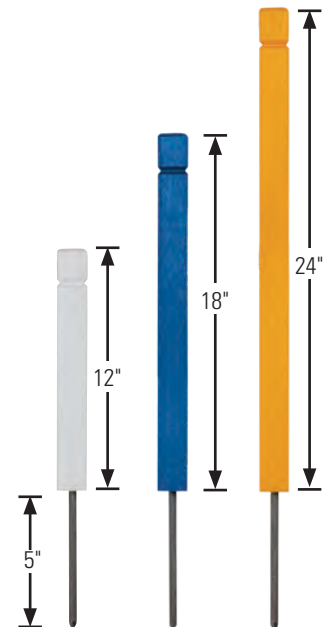

DIRECTIONAL ASSISTANCE

▶ ROPE POSTS & TRAFFIC DIVERTERS

Maintenance free and made with recycled material, each model includes a 2 spike base and is available in multiple lengths and colors. All posts are 4" x 4".

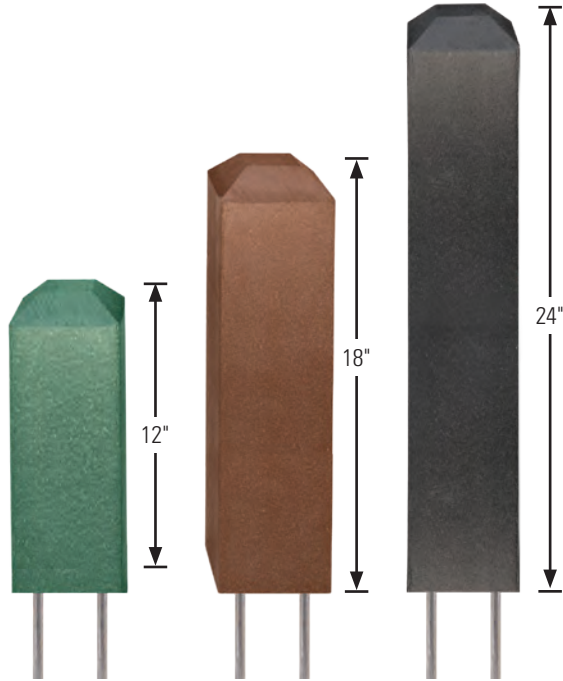

Standard Colors

	12"	18"	24"
■ Green	#405650	#405651	#405652
■ Brown	#405653	#405654	#405655
■ Black	#405656	#405657	#405658
■ White	#90569	#90570	#90571

Premium Colors

	12"	18"	24"
Walnut	#90574-WN	#90575-WN	#90576-WN

▶ SCATTER BARRIER

Perfect design and functionality for a temporary solution, each barrier directs traffic around your course, wherever you need it, whenever you need it.

4' 24 lbs., 6' 36 lbs.

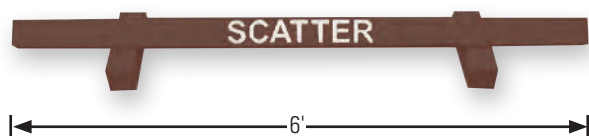
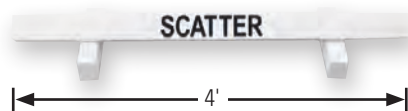

4 Foot

6 Foot

■ Green	#405665-4G	#405665-6G
■ Black	#405665-4BLK	#405665-6BLK
■ Brown	#405665-4BRN	#405665-6BRN
■ White	#405665-4W	#405665-6W



▶ **BUCKET OF STAKES**

25 white or green 8" recycled plastic stakes with spike. Includes 3.5" end cap for the top of the stake. Cap options are Green, Red, Blue and Black (19 lbs.).

Cap Color	Green Stake	White Stake
■ Green	#405841-2	#405841-1
■ Red	#405842-2	#405842-1
■ Blue	#405840-2	#405840-1
■ Black	#405843-2	#405843-1
■ White	#405844-2	#405844-1

▶ **HOLLOW BRAID ROPE**

Perfect for maintaining a consistent look all around your clubhouse and course. Available in 1/4" and 1/2" sizes.



Size	Hunter Green	Hunter Green/White	White	Black	Yellow
1/4" x 1000'	#400191	#400192	#400193	#400190	#400194
1/2" x 500'	#400196	#400197	#400198	#400195	#400199

▶ **ROPE FIDS**

Plastic "Fid" for joining or putting "Eyes" in the end of hollow braid rope.

- #F1891/4 - 1/4"
- #F1891/2 - 1/2"



BUNKER RAKES

▶ ECONOMY RAKES

15" Economy Bunker Rake with/ 54" Green Ultra Light Steel Handle (15 lbs.).

#11665ST



▶ TOUR-LITE™ RAKES

15" Tour Lite Bunker Rake with 54" Green Ultra Light Steel Handle (15 lbs.).

#12375ST



▶ TOUR PRO™

- 20" and 25" heads ensure tracks are covered with minimum effort, while pioneering design generates tournament quality surfaces.
- When durability is a must, the exclusive Gator Grip™ Handle is your best option, available in both 60" and 72" lengths.
- A single self-tapping screw (included) is all you need for assembly.

#11760ST - 20" Tour Pro Bunker Rake
w/ 54" Green Aluminum Handle (21 lbs.)

#11720ST - 20" Tour Pro Bunker Rake
w/ 60" Green Gator Handle (21 lbs.)

#11770ST - 25" Tour Pro Bunker Rake
w/ 72" Green Gator Handle (26 lbs.)



BUNKER RAKES

▶ PRO LINE RAKES

- Round tapered edges on each end for a clean finish.
- High-density lightweight polyethylene head.
- Extra strong - guaranteed "no splinter" composite handle.
- Packed in boxes of 25.

#401000 - 25" head w/ 72" handle

#401001 - 17" head w/ 54" handle



▶ TOUR SMOOTH™ II

- Smooths both fine and coarse sand into perfect playing conditions quickly and easily.
- Pair the Tour Smooth™ II with the exclusive 60" Gator Grip™ Handle for a level of performance unmatched by any of the competitors.
- A single self-tapping screw (included) is all you need for assembly.

#11800ST - 15" Tour Smooth II Bunker Rake w/ 54" Green Composite Handle (22 lbs.)

#11820ST - 15" Tour Smooth II Bunker Rake w/ 60" Green Gator Grip Handle (24 lbs.)



FAIRWAY MARKERS



▶ 2" DIAMETER FAIRWAY POLES & VINYL GUARD

- Extremely durable, factory-applied VinylGuard covering over a 2-inch diameter, 5-foot tall PVC pole
- Impervious to abrasion, UV sunlight, chemicals and the elements
- Will not tear, peel chip or fade – Shatterproof

#30-FM-2000B Black and White Fairway post

#30-FM-2000RB Red and White Fairway post



Order online 24/7 @ www.wittekgolf.com

VINYL GUARD® golf

SKU	Description	Packaging
#30-FS-5000W	½" White Vinyl Roll Renews 30 Sticks	250 ft. per roll
#30-FS-5000Y	½" Yellow Vinyl Roll Renews 30 Sticks	250 ft. per roll
#30-FS-5000B	½" Black Vinyl Roll Renews 30 Sticks	250 ft. per roll
#30-FS-5000BL	½" Blue Vinyl Roll Renews 30 Sticks	250 ft. per roll
#30-FS-5000G	½" Green Vinyl Roll Renews 30 Sticks	250 ft. per roll
#30-FS-5000R	½" Red Vinyl Roll Renews 30 Sticks	250 ft. per roll

SKU	Description	Packaging
#30-FS-7550W	¾" White Vinyl Roll Renews 30 Sticks	250 ft. per roll
#30-FS-7550Y	¾" Yellow Vinyl Roll Renews 30 Sticks	250 ft. per roll
#30-FS-7550B	¾" Black Vinyl Roll Renews 30 Sticks	250 ft. per roll
#30-FS-7550BL	¾" Blue Vinyl Roll Renews 30 Sticks	250 ft. per roll
#30-FS-7550G	¾" Green Vinyl Roll Renews 30 Sticks	250 ft. per roll
#30-FS-7550R	¾" Red Vinyl Roll Renews 30 Sticks	250 ft. per roll

SKU	Description	Packaging
#30-RH-1000G	1" Green Rake Handle Renews 50 Handles	250 ft. per roll
#30-RH-1000Y	1" Yellow Rake Handle Renews 50 Handles	250 ft. per roll
#30-RH-1000B	1" Brown Rake Handle Renews 50 Handles	250 ft. per roll

SKU	Description	Packaging
#AS-77	3M Super 77 Multi-Purpose Adhesive Spray	1 Per Box
#VT-1100	High Temperature High Velocity Heat Gun	1 Per Box



► FLEX STAKES

The ultimate in mow-over stakes, flexible and durable, Flex Stakes are color-impregnated and are low maintenance installation, and they float! Flex Set and Anchors not included.

Color	17½"	24"
<input type="checkbox"/> White	#42778	#42884
<input type="checkbox"/> Yellow	#42883	#42887
<input type="checkbox"/> Blue	#42880	#42888
<input type="checkbox"/> Green	#42881	#42889
<input type="checkbox"/> Red	#42882	#42890
<input type="checkbox"/> Red/Yellow	#42779	#42891



FLEXSTAKE

► FLEX ANCHOR

High visibility surface ring sheds water and dirt. Automatically locks stake in place.

#42960 - Black

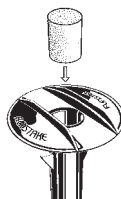

YARDAGE MARKER SYSTEMS

Made of super durable 3/4" engraved plastic, these fairway yardage markers are virtually unbreakable. Your choice of 15 1/2" round or 8" x 12" rectangular. May also be used as tee yardage markers and customized with your logo. Comes with two 4" spikes.



Color	8" Round Plain	15" Round Plain or Numbered	8" x 12" Rectangular Plain or Numbered
Red w/ White #'s	#405851	#405853	#405852
White w/ Black #'s	#405856	#405858	#405857
Blue w/ White #'s	#405861	#405863	#405862
Yellow w/ Black #'s	#405866	#405868	#405867
Black w/ White #'s	#405871	#405873	#405872
Green w/ White #'s	#405876	#405878	#405877



THE KIRBY MARKER SYSTEM

- Choose the complete Kirby Marker System used by thousands of courses worldwide to speed up play, build revenue and increase golfer satisfaction.
- Patented collapsible markers in red, white, blue, yellow, green and black.



- #59400 - Red ■ #59400-1 - Red Collar
- #59401 - White □ #59401-1 - White Collar
- #59402 - Blue ■ #59402-1 - Blue Collar
- #59403 - Yellow ■ #59403-1 - Yellow Collar
- #59404 - Green ■ #59404-1 - Green Collar
- #59406 - Black ■ #59406-1 - Black Collar
- #59409 - Anchor Collar
- #F110AP - Anchor Pipe



#59405 - Custom Marker

Check your order history @ www.wittekgolf.com

DIVOT BOTTLE STORAGE

▶ DIVOT MIX BOTTLES

- A - #18802 - Seed and Soil Bottle Only 14" tall
- B - #41333 - 35 oz top Fill, Curved Neck 14" tall
- C - #41313 - 45 oz Bottom Fill, Curved Grip Neck 14" tall
- D - #41303 - 45 oz Bottom Fill, Curved Neck 14" tall
- E - #41363 - 32 oz Bottle with Lid 9" tall
- F - #41370 - Kaddie clip 13" tall
- G - #41299 - Divot Bottle w/ Handle



▶ CLUB & BALL CLEANER ATTACHMENT

Attach it to a cart or sell it for personal use, it's the perfect addition to make sure your guests are keeping their equipment clean.

6"H x 10"L x 6"W (2 lbs.)

- #BW1504 - Ball Washer Complete
- #BW1514 - Ball Washer w/Plastic Bracket
- #BW1534 - Ball Washer w/PC Metal Bracket
- #BW1565 - Ball Washer w/Precedent Bracket



Color choices for all recycled plastic products

Green Brown Black

Driftwood Walnut

▶ SMALL DIVOT BOTTLE BOX

- Holds 12 bottles
 - Compact. Portable. Rugged.
 - Bottles not included.
- 16"H x 18"W x 13"D (20 lbs.)

- #405365 - Green
- #405366 - Brown
- #405367 - Black
- #405368 - Driftwood
- #405366WN - Walnut



▶ SMALL DIVOT BOTTLE CADDIE

Model holds 12 bottles.

Bottles not included.

17"W x 18"H x 21½"D (32 lbs.)

- #405360 - Green
- #405361 - Brown
- #405362 - Black
- #405363 - Driftwood
- #405361WN - Walnut



▶ MEDIUM DIVOT BOTTLE BOX

- Stylish heavy-built frame housing.
 - Holds 24 bottles.
 - Bottles not included.
- 24" x 17" x 36" (72 lbs.)

- #405370 - Green
- #405371 - Brown
- #405372 - Black
- #405374 - Driftwood
- #405371WN - Walnut



▶ MEDIUM DIVOT BOTTLE RACK

- Holds 24 bottles.
- Comes with 4" x 4" x 60" posts for permanent in-ground installations.
- Convenient leveling feet for placement on surfaces also available upon request for an additional charge.

- Bottles not included.
- 41"W x 60"H x 16"D (100 lbs.)
- #405375 - Green
 - #405376 - Brown
 - #405377 - Black
 - #405379 - Driftwood
 - #405376WN - Walnut

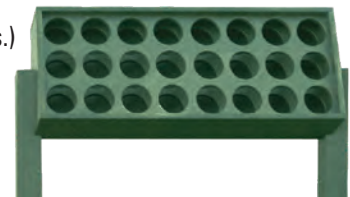

DIVOT MIX STORAGE

Give a different look to your divot mix boxes with one of these innovative models. Made with recycled material, each model is designed to be appealing and functional.

NEW in 2019



WINDY CITY DIVOT BOX

- Divot Mix and Trash container includes liners and lids
- UV - Resistant
- 8 - Gallons (30 L)
- Container Dimensions: 16"x 16"W x 19"H
- Attractive side panels dress up the range or tee area

- #4053GN - Green
- #4053BN - Brown
- #4053BK - Black

ROUND DIVOT MIX CONTAINERS



Weather proof 100% recycled plastic lumber round Divot Mix Containers. Features a recycled plastic frame, three pointed slats for anchoring and a heavy duty recycled plastic lid. All units include easily removable plastic bucket and scoop.

- 5 gal: 18" x 18" x 18" (29 lbs.)
- 10 gal: 21½" x 21½" x 23" (38 lbs.)

- | | |
|---------------------|---------------------|
| 5 Gallon | 10 Gallon |
| #405310 - Green | #405315 - Green |
| #405311 - Brown | #405316 - Brown |
| #405312 - Black | #405317 - Black |
| #405313 - Driftwood | #405318 - Driftwood |
| #405311WN - Walnut | #405316WN - Walnut |

Color choices for all recycled plastic products



DIVOT MIX CONTAINER ON WHEELS



We've added wheels and a removable handle to our T306 Divot Container to make it more mobile. Simply place the handle in the coupling on the back to relocate the unit and then take the handle to the next container. Includes scoop. 18" H x 12½" W x 19" D With Wheels (29 lbs.) 5 gal. Without Wheels (23 lbs.) 5 gal.

- | | |
|------------------------|----------------------|
| #T306WHG - Green | #T306G - Green |
| #T306WHBRN - Brown | #T306BRN - Brown |
| #T306WHBLK - Black | #T306BLK - Black |
| #T306WHDRT - Driftwood | #T306DRT - Driftwood |
| #T306WHWN - Walnut | #T306WN - Walnut |

#200928 - Replacement Scoop



DIVOT MIX CONTAINERS

These sturdy boxes are made from solid recycled plastic lumber. The board joints are tongue and groove containing divot mix internally. Sturdy legs support the box off the ground to protect turf. Great for busy Par 3 tee boxes or cart bottle refill stations. 28"H x 21"W x 32"L (75 lbs.). Includes scoop.

- #T305G - Green
- #T305BRN - Brown
- #T305BLK - Black
- #T305DRT - Driftwood
- #T305WN - Walnut



#200928 - Replacement Scoop



Chat with specialists @ www.wittekgolf.com

TRASH CONTAINERS



▶ STAINLESS STEEL LITTER CADDIE™ WITH SPIKE

- Stainless ... the name says it all.
- 20-gallon capacity, rust-proof caddie.
 - Designed for long life and easy bag removal.
 - Use heavy-duty steel base or spikes for in-ground installations.

Color	20 gallon 12" spike	20 gallon base
Green	#13975ST	#13978ST
Black	#13995ST	#13998ST
Red	#13950ST	#13953ST



▶ THE ORIGINAL TAPERED LITTER CADDIE

Perfectly shaped to properly contain trash contents. 20-gauge steel with rich, durable powder-coat finish.

Color	9 gallon 4 3/4" spike	9 gallon base	30 gallon 12" spike	30 gallon base
Green	#13700ST	#13800ST	#13075ST	#13078ST
Black	#13195ST	#13197ST	#13095ST	#13098ST
Red	#13150ST	#13152ST	#13050ST	#13053ST



▶ 9 GALLON TUFF GUY™ LITTER CADDIE

- Inexpensive, High-impact resistant
- Conceals unsightly trash
- Low-maintenance—wipes clean
- Returns to original shape if buckled
- Colorfast
- Comes with a removable 6" spike
- 14" x 14" x 16" H (4.75 lbs.)
- Personalize with your course logo

Call For Pricing

- #T162G - Green
- #T162BLK - Black

Color choices for all recycled plastic products

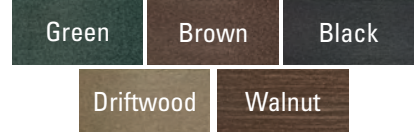

Call For Pricing on personalization



▶ KOLORCAN™ 32 GALLON RECEPTACLE, WASTE TOP, LINER

19"W x 38"H x 19"D (23 lbs.)

- #405230 - Green Solid
- #405231 - Black Solid



▶ KOLORCAN™ 42 GALLON RECEPTACLE, DOME TOP, LINER

24"W x 38"H (33 lbs.)

- #405220 - Green Solid
- #405221 - Black Solid

NEW in 2019



▶ **10 GALLON ROUND TRASH CONTAINER**



Weather proof 100% recycled plastic lumber constructed 10 gallon Trash Container. All units include an easily removable plastic bin. 21" top diameter x 22½" H (38 lbs.)

- #T322G - Green
- #T322BRN - Brown
- #T322BLK - Black
- #T322DRT - Driftwood
- #T322WN - Walnut



▶ **WINDY CITY TRASH CONTAINER**

- 8 - Gallons (30L)
- Container Dimensions: 16"x16"x19"
- Attractive side panels dress up the range or tee area
- UV - Resistant

- #4054GN - Green
- #4054BN - Brown
- #4054BK - Black
- #778Liner - Replacement Liner



▶ **22 Gallon Square Trash Can**



These units are all made from low maintenance recycled plastic lumber. Each unit includes a firm internal trash container for easy dumping and is accessed by lifting off the flat top. 36½" H, 18" W and 19" D (70 lbs.). Please call for logo options.

- #T188G - Green
- #T188BRN - Brown
- #T188BLK - Black
- #T188D - Driftwood
- #T188WN - Walnut



▶ **22 Gallon Flat Top Arched Trash Can**



This great looking trash container includes a 22 gallon trash bin. 20"L x 20"W x 45"H (78 lbs.)

#T189



▶ **22 GALLON ROUND TRASH RECEPTACLE**



These 22 gallon containers feature thinner, tighter slats creating a barrel-style design. Recycled plastic lumber frames and donut lid. Includes an internal trash bin. 20½" x 20½" x 31" H (48 lbs.)

- #T195G - Green
- #T195BRN - Brown
- #T195BLK - Black
- #T195DRT - Driftwood
- #T195WN - Walnut



▶ **SQUARE PULL-TOP TRASH RECEPTACLE**



Made from low maintenance recycled plastic lumber. Includes a firm internal trash container for easy dumping and is accessed by lifting off the flat top. 25" H x 21" W x 21" D (50 lbs.).

- #T180G - Green
- #T180BRN - Brown
- #T180BLK - Black
- #T180DRT - Driftwood
- #T180WN - Walnut

Reorder easily @ www.wittekgolf.com

WATER STATIONS

Maintenance free and made with recycled material. Each model is heavy duty and designed to last. Available in a variety of sizes and designs to fit your needs.



▶ RAISED ICE CHEST ENCLOSURE

Model encloses a 54 qt. ice chest. Ice chest is included. 31"W x 24"H x 19"D
Weight 67 lbs.

#405480 - Green
#405481 - Brown
#405482 - Black
#405483 - Driftwood
#405481WN - Walnut

Color choices for all recycled plastic products

Green	Brown
Black	Driftwood
Walnut	



▶ TRIPOD WATER STATION

Holds 10-gallon cooler (not included). 20"W x 36"H x 20"
Weight 25 lbs.

#405450 - Green
#405451 - Brown
#405452 - Black
#405453 - Driftwood
#405451WN - Walnut



▶ DELUXE TRIPOD WATER STATION

Foldable and portable base. Design includes lockable door. Holds 10-gallon cooler (not included). 25"W x 67½"H
Weight 70 lbs.

#405455 - Green
#405456 - Brown
#405457 - Black
#405458 - Driftwood
#405456WN - Walnut



▶ HUNTER GREEN 10 GALLON IGLOO WATER COOLER

16"W x 23"H. Weight: 12 lbs.

#42015

▶ SPIGOT FOR IGLOO COOLER

#45315ST



▶ CUP DISPENSER

Our durable dispenser fits brackets on plastic and metal water coolers. Made of plastic. Holds 4¼" ounce cone cup. 13½"H x 2½"W. Weight: 1 lb.

A. #42011
B. #54214
C. #45600ST



▶ PAPER CUPS - CASE OF 5000

Cone shaped cups hold 4¼ ounces. Color: White. Weight: 25 lbs.

#42009

▶ METAL CUP DISPENSER REPLACEMENT LID

#45605ST

▶ **OPEN BASE WATER STATION**

Model designed with versatility in mind, 4-post open-stand housing holds 10-gallon cooler (not included) and includes cup dispenser.

23"W x 70"H x 23"D
Weight 125 lbs.

- #405460 - Green
- #405461 - Brown
- #405462 - Black
- #405464 - Driftwood
- #405461WN - Walnut



▶ **FULL ENCLOSURE WATER STATION**

Holds 10-gallon cooler (not included) and includes cup dispenser, self-closing trash door and liner.

27"W x 70"H x 24"D
Weight 145 lbs.

- #405465 - Green
- #405466 - Brown
- #405467 - Black
- #405468 - Driftwood
- #405466WN - Walnut



▶ **DOUBLE FULL ENCLOSURE WATER STATION**

Housing holds two 10-gallon coolers (not included) and includes cup dispensers, self-closing trash doors and liners.

50"W x 71"H x 24"D
Weight 250 lbs.

- #405475 - Green
- #405476 - Brown
- #405477 - Black
- #405478 - Driftwood
- #405476WN - Walnut



Color choices for all recycled plastic products

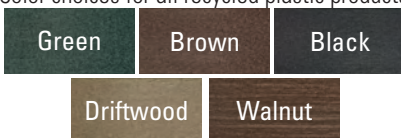

Use your terms @ www.wittekgolf.com

PODIUMS



▶ SCORE CARD CADDIE WITH POST

Hinged lid with dividers makes it perfect for storage of scorecards and pencils. 5' post included.

Size: 18"D x 12½"W x 66"H.

Weight 45 lbs.

#405200 - Green

#405201 - Brown

#405202 - Black

#405204 - Driftwood

#405201WN - Walnut



▶ LARGE PODIUM

The perfect podium for your course, valet and anywhere else at your facility. Made from 100% recycled plastic lumber, with a built-in shelf and an opening top piece for storage. Call to discuss trim, logo, and paneling options! 24"L x 24"W x 49"H (96 lbs.)

#T071GRN - Green

#T071BRN - Brown

#T071BLK - Black

#T071DRT - Driftwood

#T071WN - Walnut



▶ ARCH DESIGN PODIUM

For your greeter or starter, this fantastic looking podium will give you years of use with little to no maintenance required.

Made of 100% recycled plastic lumber.

Comes with a shelf and a double-door cabinet. Logos can be added.

37" long, 20" wide, 51" high.

Weight 120 lbs.

Please call to discuss:

Logo - Paneling - Trim

#T069A

Color choices for all recycled plastic products

Green

Brown

Black

Driftwood

Walnut

 **BENCHES**

RANGE EQUIPMENT

RANGE SUPPLIES

GOLF COURSE ACCESSORIES

IRRIGATION & MAINTENANCE

PRO SHOP ACCESSORIES

MINI GOLF

▶ **MALL BENCH**

Model features flat seating and includes stainless steel hardware.
4' long, 20" wide, 17" high. (45 lbs.)
6' long, 20" wide, 17" high. (75 lbs.)

- | | |
|---------------------|---------------------|
| 4 Foot | 6 Foot |
| #405520 - Green | #405530 - Green |
| #405521 - Brown | #405531 - Brown |
| #405522 - Black | #405532 - Black |
| #405524 - Driftwood | #405534 - Driftwood |
| #405521WN - Walnut | #405531WN - Walnut |



▶ **HIGH BACK BENCH**

Model features flat seating with back support and includes stainless steel hardware.
4' long, 26" wide, 34" high. (70 lbs.)
6' long, 26" wide, 34" high. (105 lbs.)

- | | |
|---------------------|---------------------|
| 4 Foot | 6 Foot |
| #405500 - Green | #405510 - Green |
| #405501 - Brown | #405511 - Brown |
| #405502 - Black | #405512 - Black |
| #405504 - Driftwood | #405514 - Driftwood |
| #405501WN - Walnut | #405511WN - Walnut |



▶ **HERITAGE BENCH**

The 6' Heritage Bench offers comfort and style and requires minimal maintenance. Made from 100% recycled plastic lumber, the Heritage will never chip, rot, split or need painting. Modeled after traditional wood benches, this recycled plastic lumber bench offers the best in style and durability. The seat area is contoured for comfort and arm rests are convenient when relaxing. Colorfilled custom wording may be possible - please call to discuss. 72" long, 25" wide, 36" high. Weight 100 lbs.

- #T245G - Green
- #T245BRN - Brown
- #T245BLK - Black
- T245DRT - Driftwood
- #T245WN - Walnut

Color choices for all recycled plastic products

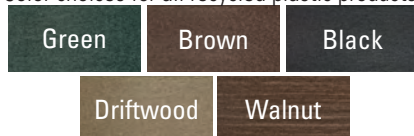

See your invoices/statements @ www.wittekgolf.com

HUNTINGTON HIGH TOP COLLECTION

HUNTINGTON HIGH TOP COLLECTION

Wittek & Eagle One's Huntington High Top Collection is the perfect addition to any outdoor patio or 19th hole area. With three seating options and either a bar or high-top table, this collection withstands the test of time. Made from 100% recycled plastic, the bar can be customized with your logo, call to discuss paneling, trim and customization!



HUNTINGTON HIGH TOP TABLE

Size: 31" DIA x 43"H.
Weight: 73 lbs.

- #C320BLK - Black #C320DRT - Driftwood
- #C320BRN - Brown #C320WHT - White
- #C320GRN - Green #C320WN - Walnut



HUNTINGTON BIG BAR

Size: 77"L x 25"W x 42"H
Weight: 270 lbs.

- #C900BLK - Black #C900DRT - Driftwood
- #C900BRN - Brown #C900WHT - White
- #C900GRN - Green #C900WN - Walnut

Color choices for all recycled plastic products

Black	Brown	Green
Driftwood	White	Walnut



HUNTINGTON HIGH TOP CHAIR

Size: 28"L x 25"W x 47"H.
Weight: 40 lbs.

- #C321BLK - Black #C321DRT - Driftwood
- #C321BRN - Brown #C321WHT - White
- #C321GRN - Green #C321WN - Walnut



HUNTINGTON BAR STOOL

Size: 13" DIA x 30"H.
Weight: 13 lbs.

- #C363BLK - Black #C363DRT - Driftwood
- #C363BRN - Brown #C363WHT - White
- #C363GRN - Green #C363WN - Walnut

CAPE COD DINING COLLECTION



▶ CAPE COD DINING COLLECTION

Wittek & Eagle One's Cape Cod dining collection is available in rectangle and square designs, featuring a simple and timeless look that is sure to impress your guests. Made from 100% recycled plastic, and with a variety of seating options available, the Cape Cod collection is the perfect outdoor dining solution.

Umbrella and cushions not included.

▶ CAPE COD SQUARE DINING TABLE 42"

Size: 42"L x 42"W x 31"H.
Weight: 114 lbs.

- #C38542BLK - Black
- #C38542BRN - Brown
- #C38542GRN - Green
- #C38542DRT - Driftwood
- #C38542WHT - White
- #C38542WVN - Walnut



▶ CAPE COD SQUARE DINING TABLE 60"

Size: 60"L x 60"W x 31"H.
Weight: 188 lbs.

- #C3856060BLK - Black
- #C3856060BRN - Brown
- #C3856060GRN - Green
- #C3856060DRT - Driftwood
- #C3856060WHT - White
- #C3856060WVN - Walnut



▶ CAPE COD DINING TABLE 60"

Size: 60"L x 42"W x 31"H.
Weight: 131 lbs.

- #C38560BLK - Black
- #C38560BRN - Brown
- #C38560GRN - Green
- #C38560DRT - Driftwood
- #C38560WHT - White
- #C38560WVN - Walnut



▶ CAPE COD STACKABLE CHAIR

Size: 27"L x 20"W x 38"H.
Weight: 25 lbs.

- #C362BLK - Black
- #C362BRN - Brown
- #C362GRN - Green
- #C362DRT - Driftwood
- #C362WHT - White
- #C362WVN - Walnut



▶ CAPE COD DINING CHAIR

Size: 30"L x 27"W x 41"H.
Weight: 33 lbs.

- #C361BLK - Black
- #C361BRN - Brown
- #C361GRN - Green
- #C361DRT - Driftwood
- #C361WHT - White
- #C361WVN - Walnut



▶ CAPE COD ROCKER CHAIR

Size: 36"L x 27"W x 40"H.
Weight: 40 lbs.

- #C367BLK - Black
- #C367BRN - Brown
- #C367GRN - Green
- #C367DRT - Driftwood
- #C367WHT - White
- #C367WVN - Walnut

Order online 24/7 @ www.wittekgolf.com

THE ADIRONDACK SERIES

▶ THE ADIRONDACK SERIES

A staple for golf courses, pools and any outdoor facility featuring a timeless look and unmatched quality, made from 100% recycled plastic



▶ ADIRONDACK END TABLE

Size: 19"L x 19"W x 18"H.
Weight: 21 lbs.

#C471BLK - Black
#C471BRN - Brown
#C471GRN - Green
#C471DRT - Driftwood
#C471WHT - White
#C471WN - Walnut



▶ ADIRONDACK FOOT STOOL

Size: 16"L x 22"W x 22"H.
Weight: 19 lbs..

#C426BLK - Black
#C426BRN - Brown
#C426GRN - Green
#C426DRT - Driftwood
#C426WHT - White
#C426WN - Walnut



▶ CLASSIC ADIRONDACK

Size: 32"L x 30"W x 38"H.
Weight: 35 lbs.

#C4261BLK - Black
#C4261BRN - Brown
#C4261GRN - Green
#C4261DRT - Driftwood
#C4261WHT - White
#C4261WN - Walnut



▶ COZY ADIRONDACK

Size: 32"L x 30"W x 32"H.
Weight: 30 lbs.

#C428BLK - Black
#C428BRN - Brown
#C428GRN - Green
#C428DRT - Driftwood
#C428WHT - White
#C428WN - Walnut



▶ DOUBLE ADIRONDACK

Size: 72"L x 34"W x 38"H.
Weight: 90 lbs

#C427BLK - Black #C427DRT - Driftwood
#C427BRN - Brown #C427WHT - White
#C427GRN - Green #C427WN - Walnut



▶ ADIRONDACK BENCH

Size: 56"L x 36"W x 38"H.
Weight: 62 lbs.

#C432BLK - Black #C432DRT - Driftwood
#C432BRN - Brown #C432WHT - White
#C432GRN - Green #C432WN - Walnut

THE HERITAGE COLLECTION

▶ THE HERITAGE COLLECTION

Create a lounge area that your guests won't want to leave. The heritage collection features cozy and practical solutions for any and every outdoor lounge area.



▶ HERITAGE END TABLE

Size: 26" L x 24" W x 16" H.
Weight: 29 lbs.

- #C358BLK - Black #C358DRT - Driftwood
- #C358BRN - Brown #C358WHT - White
- #C358GRN - Green #C358WN - Walnut



▶ HERITAGE COFFEE TABLE

Size: 48" L x 24" W x 16" H.
Weight: 56 lbs.

- #C359BLK - Black #C359DRT - Driftwood
- #C359BRN - Brown #C359WHT - White
- #C359GRN - Green #C359WN - Walnut

Color choices for all recycled plastic products

Black	Brown	Green
Driftwood	White	Walnut



▶ 2' HERITAGE CHAIR

Size: 36" L x 25" W x 36" H.
Weight: 51 lbs.

- #T2452BLK - Black
- #T2452BRN - Brown
- #T2452GRN - Green
- #T2452DRT - Driftwood
- #T2452WHT - White
- #T2452WN - Walnut



▶ 4' HERITAGE BENCH

Size: 48" L x 25" W x 36" H.
Weight: 70 lbs.

- #T2454BLK - Black
- #T2454BRN - Brown
- #T2454GRN - Green
- #T2454DRT - Driftwood
- #T2454WHT - White
- #T2454WN - Walnut



▶ 6' HERITAGE BENCH

Size: 72" L x 25" W x 36" H.
Weight: 100 lbs.

- #T245BLK - Black
- #T245BRN - Brown
- #T245GRN - Green
- #T245DRT - Driftwood
- #T245WHT - White
- #T245WN - Walnut

Check your order history @ www.wittekgolf.com

TABLES AND MORE



▶ 6' BARRIER W/ T FEET

Size: 72"L x 14"W x 44"H.

Weight: 49 lbs.

#C7006BLK - Black #C7006DRT - Driftwood
 #C7006BRN - Brown #C7006WHT - White
 #C7006GRN - Green #C7006WN - Walnut



▶ SYDNEY 48" DECK BOX

Size: 48"L x 18"W x 18"H.

Weight: 75 lbs.

#C3954BBLK - Black #C3954BDRT - Driftwood
 #C3954BBRN - Brown #C3954BWHT - White
 #C3954BGRN - Green #C3954BWN - Walnut

Color choices for all recycled plastic products

Black	Brown	Green
Driftwood	White	Walnut



▶ HEXAGONAL PICNIC TABLE

Size: 76"L x 76"W x 32"H.

Weight: 226 lbs. ADA option available.

#C3559BLK - Black #C3559DRT - Driftwood
 #C3559BRN - Brown #C3559WHT - White
 #C3559GRN - Green #C3559WN - Walnut



▶ 6' RECTANGULAR PICNIC TABLE

Size: 72"L x 50"W x 36"H.

Weight: 215 lbs. ADA option available.

#C3506BLK - Black #C3506DRT - Driftwood
 #C3506BRN - Brown #C3506WHT - White
 #C3506GRN - Green #C3506WN - Walnut

COURSE COLLECTIONS

CONTEMPORARY COLLECTION

Modern, simple, and maintenance free. Our Contemporary Collection of recycled plastic products features no paneling, which means they look even better with your custom logo. Even without it, this new and sleek style looks great in any setting.



NEW ENGLAND COLLECTION

The New England Collection, the timeless paneling style for golf courses everywhere. With squared paneling and sleek trim options, the New England Collection of recycled plastic furniture brings a timeless and professional look to your facilities tee boxes and the areas around your clubhouse.



CONTOUR COLLECTION

Create the elegant look you've always wanted at your course with the Contour Collection of recycled plastic furnishings. Featuring rounded arches and paneling to give your course an elegant and refined look, at a reasonable price. The Contour Collection will keep your course looking its best year after year.



Chat with specialists @ www.wittekgolf.com

TEE CONSOLES

It's easy to customize the perfect tee console for your course. Simply follow steps 1 through 4. Pick your stand. Then, configure it with the exact options you want for your tee boxes.

1 PICK A STAND

Permanent Mounting Post
2 $\frac{3}{8}$ " Diameter
#36248ST



Junior Tee Console
Base 19" W
#36200ST



Tradition™ Tee Console
Base 19" W
#36230ST



2 ADD A BALL WASHER



Premier Ball Washer
Single Ball/Plunger-style
Capacity 3.6 L

Green ■ #1450ST

Black ■ #1470ST

Red ■ #1425ST



Medalist Ball Washer
Single Ball/Plunger-style
Capacity 1.6 L

Green ■ #1550ST

Black ■ #1570ST

Red ■ #1525ST



Classic Ball Washer
Four Ball/Crank-style
Capacity 1.8 L

Green ■ #1350ST

Black ■ #1370ST

Red ■ #1325ST

3 ADD TRASH RECEPTACLES



Litter Mate

- Includes hardware and trash opening lids.
- 9-gallon (34 L.) capacity per unit
15" W x 12" D x 21" H

	Single	Double
Green ■	#12850ST	#12950ST
Black ■	#12870ST	#12970ST
Red ■	#12825ST	#12925ST



9-Gallon (34 L.) Litter Caddy - with Spike

Green ■	#13700ST
Black ■	#13195ST
Red ■	#13150ST

4 ADD SPIKE BRUSHES

#14252ST Replacement Brush Gray

#36156BST Console Spike Kleener
Black w/ Bracket/ Gray Brush

CONSOLE KITS & TOWELS

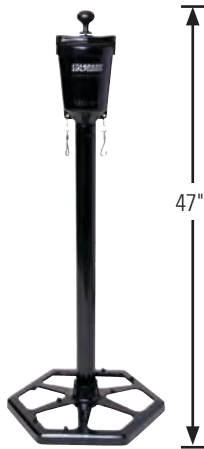

▶ TRADITION™ TEE CONSOLE KIT 1

- Includes Tradition™ Console Stand (Black) and your choice of a Premier™ or Medalist™ Ball Washer.

	Premier Tee Kit 1	Medalist Tee Kit 1
Green	#39150ST	#39250ST
Black	#39170ST	#39270ST
Red	#39125ST	#39225ST



▶ TRADITION™ TEE CONSOLE KIT 2

- Includes Tradition™ Console Stand (Black), your choice of a Premier™ or Medalist™ Ball Washer, plus matching single Litter Mate™ unit.

	Premier Tee Kit 2	Medalist Tee Kit 2
Green	#39350ST	#39450ST
Black	#39370ST	#39470ST
Red	#39325ST	#39425ST



▶ TRADITION™ TEE CONSOLE KIT 3

- Includes Tradition™ Console Stand (Black), your choice of a Premier™ or Medalist™ Ball Washer, plus matching double Litter Mate™ unit.

	Premier Tee Kit 3	Medalist Tee Kit 3
Green	#39550ST	#39650ST
Black	#39570ST	#39670ST
Red	#39525ST	#39625ST

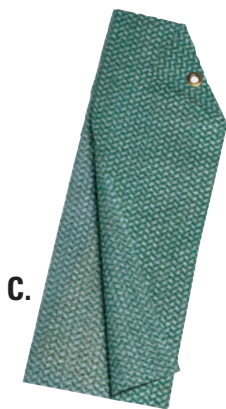
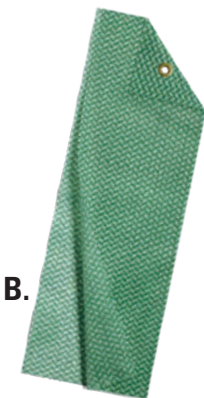

A. GREEN WASHABLE TEE TOWELS

Absorbent and reusable.
200 per case.
Size: 21"H x 7"W duo-fold.
#4970ST

B. GREEN & WHITE ECONOMY TEE TOWELS

Stay stocked, even on tight budgets.
200 per case.
Size: 21"H x 7"W duo-fold.
#4969ST

C. GREEN & WHITE DISPOSABLE TOWELS

Reinforced with nylon threads and tough metal eyelet.
200 per case.
Size: 21"H x 7"W tri-fold.
#40965ST

D. LARGE COTTON TOWELS

Priced/Dz.
Size: 18"H x 6"W tri-fold.
#4100ST - White
#4200ST - Green

E. EMBROIDERED TOWELS

Priced/Dz.
Size: 18"H x 6"W tri-fold.
#405185-E - White
#405186-E - Green

Reorder easily @ www.wittekgolf.com

MAINTENANCE ACCESSORIES



▶ SUN HELMET

This light weight sun helmet comes complete with replaceable and adjustable liner and sweat band for comfort and a chin strap. They are made from stabilized polypropylene and are not ANSI approved. Tan color only.

#400610



▶ SAFARI HAT

This plastic molded safari hat offers full wide brim and side louvers allow maximum circulation of air around the head. Adjustable inner headband fits all head sizes. Custom logos available.

#400606 - Beige



▶ MESH HELMET

The mesh material allows for ventilated circulation, keeping the head cool. Complete with replaceable and adjustable liner and sweat band for comfort and a chin strap.

#400604 - Beige



▶ WRAP-AROUND SAFETY GLASSES

- One-piece wraparound lens allows maximum safety and unobstructed vision.
- Flexible temples and non-slip rubber head grips.

#75000ST - Clear

#75050ST - Tinted



▶ BYPASS LOPPERS

#400744 - 26" Wood Handle

#400745 - 32" Wood Handle



▶ ICE PICK

#400733



▶ TINGLEY GUM BOOTS

Considered best in its class. Outsole spits out debris providing excellent gripping action without damaging turf. Light and flexible. Please specify size when ordering.



▶ TINGLEY HI-TOP OVERSHOES

One piece injection molded with slip resistant tread known for being the finest brand in the world. Please specify size when ordering.

#400650 - Small

#400651 - Medium

#400652 - Large

#400653 - XLarge

#400654 - 2 XLarge



▶ SOFT FOAM EARPLUGS

- Made of self-adjusting foam with a tapered shape for increased comfort.
- Each pair of earplugs comes in a poly bag, keeping them clean before use.

#75100ST - Box of 200

▶ **MARKING WAND**

Compatible with any brand of marking paint.

#405917



▶ **RUST-OLEUM® MARKING PAINT**

More feet per can means fewer cans of paint to buy, every foot of Rust-Oleum® marking paint you lay down is more money saved.

Available in 12 vivid colors for temporary markings on grass, gravel, concrete or asphalt.

Twelve (12) 17 oz. cans per case.



#405900 - White

#405901 - Bright Yellow

#405902 - Safety Red

#405903 - Alert Orange

#405904 - Safety Green

#405906 - Caution Yellow

#405907 - Caution Blue

#405908 - Fluorescent Pink

#405909 - Fluorescent Orange

#405910 - Fluorescent Green

#405911 - Fluorescent Red/Orange

#405912 - Black

▶ **RUST-OLEUM® PAINT SPRAY SMART**

Golf course markings have never been easier! The SpraySmart system is a patent-pending, propellant free spray system for spraying marking paint. The reusable device operates on compression technology to spray paint using SpraySmart» disposable paint pouches. You get the same great coverage, color and durability you would expect from a Rust-Oleum product but with less waste. Propellant free formula sprays on any substrate and in any weather condition; even works on dew covered grass. Designed to fully empty each paint pouch - no waste. Bright and durable colors are safe for grass. Space saving paint pouches can be easily stored or shipped (including overnight air shipping). Device fits in existing marking paint wands. Non-clogging spray tip provides one pass coverage. 12 pouches per case.



▶ **SPRAYSMART SYSTEM**

#52840



#52853 - Alert Orange

#52860 - Black

#52855 - Caution Blue

#52861 - Caution Yellow

#52858 - Fluorescent Green

#52857 - Fluorescent Orange

#52856 - Fluorescent Pink

#52859 - Fluorescent Red/Orange

#52851 - High Visibility Yellow

#52854 - Safety Green

#52862 - Safety Purple

#52852 - Safety Red

#52850 - White

Use your terms @ www.wittekgolf.com

HOLE CUTTERS & SHELLS



▶ PRO II FOOT EJECTOR HOLE CUTTER

- Simple, economical and ready to cut.
- Hot-rolled tubing and carbon steel shaft.
- Adjustable depth collar with foot ejector.

#28700ST - Cutter, Straight, Sharpened Inside
#28800ST - Cutter, Scalloped, Sharpened Inside
#28801ST - Cutter, Scalloped, Sharpened outside
#28775ST - 6" Cutter, Straight, Sharpened Inside
#28785ST - 8" Cutter, Straight, Sharpened Inside



▶ TURFMASTER® HOLE CUTTER

- Razor-sharp outside sharpened blades prevent soil compaction and minimize impact on the putting surfaces and fragile root systems.

- Use rubber mallet to drive in the blade halves.

- 20" H (10.65 lbs)

#28000ST- Turf Master Hole Cutter
#28002ST - Replacement Blade (2 per unit)



▶ MAGNUM® LEVER ACTION HOLE CUTTER

- Field-tested and proven in all soils... with flying colors.
- Smooth lever action.
- Full selection of cutter shells to match your conditions.
 4¼" Diameter

#28960ST - Cutter, Straight, Sharpened Inside
#28970ST - Cutter, Scalloped, Sharpened Inside
#28980ST - Cutter, Scalloped, Sharpened outside

▶ REPLACEMENT SHELLS

Fits Magnum, Pro II & Par Aide Hole Cutters
 Standard Golf recommends inside sharpened cutting blades primarily for sand greens. They pack the sand tighter and hold it more firmly in place.



Trouble disengaging plugs? Spend just a few minutes sanding the inside of the blade with emery paper. You'll be amazed at how much easier it is to unplug.

#28927ST - Straight, Sharpened Inside
#28952ST - Scalloped, Sharpened Inside
#28953ST - Scalloped, Sharpened Inside for Side Mounted Hole Cutters
#28990ST - 6" Cutter, Straight, Sharpened Inside
#28777ST- 6" Straight, Sharpened Inside
#28787ST - 8" Straight, Sharpened Inside

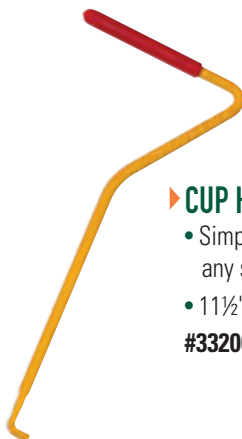

▶ CUP HOOK

- Simple and easy way to remove any style cup.
- 11½" long

#33200ST



▶ CUP SETTER

- Set it, step on it and lift it out.
- Sets cup to USGA-specs - 1" below surface of the green.
- Flattens and smoothes crowning caused by hole cutters.
- Minimizes damage to the rims of aluminum cups.

#30100ST

HOLE CUTTERS & ACCESSORIES

RANGE EQUIPMENT

RANGE SUPPLIES

GOLF COURSE ACCESSORIES

IRRIGATION & MAINTENANCE

PRO SHOP ACCESSORIES

MINI GOLF



▶ HOLEMASTER® HOLE CUTTER

Cutting into hard soil greens? Make it cleaner and easier.

- Durable, outside sharpened case-hardened blades reinforced with webs and backing plates.
 - Side pins lock in shell for easy extraction, rubber mallet drives blade halves home.
- 4¼" Diameter

#28350ST - Hole Master Hole Cutter

#28352ST - Replacement Blade (2 per unit)

▶ PRECISION HOLE CUTTER

This is the professional's hole cutter, with features including:

- Utilizing a built in slide hammer (with noise damper) for easy and accurate cutting.
- Built in level on the handle for vertical cutting.
- Two cutting depth gauges for regulation and putting cup depths, making the depth right every time.
- Quick blade change over.
- Padded handles for comfort.
- Two blade choices for either sand or clay.
- 4½" L x 4½" W x 36" H

The precision cutter has proven to reduce cup changing time by approximately 30 minutes per day on a typical eighteen hole course. Weight 17 lbs.

#G490 - Hole Cutter For Sand Greens
#G491 - Replacement Blade - Sand

#G490C - Hole Cutter For Clay Greens
#G491C - Replacement Blade - Clay

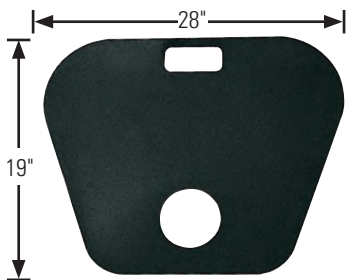
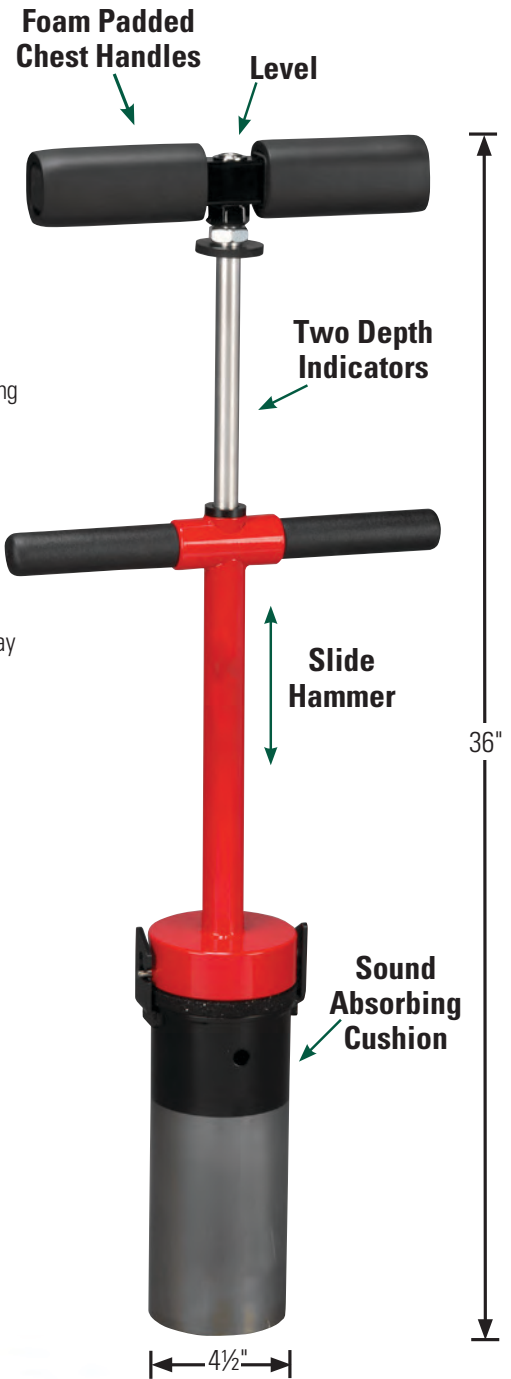

▶ HOLE CUTTER GUIDE

1" Thick
5.35 lbs.
#28500ST .



▶ HOLE CUTTER DEPTH GAUGE

Ensures consistent, accurate cuts w/ Magnum™ or Pro II Hole Cutters.
#28600ST - Depth Gauge .



▶ SHARPENER

- Works with scalloped or straight cutter styles – inside or outside.
 - Keep shells sharp for easier cuts and precision cut hole edges.
- #28400ST

See your invoices/statements @ www.wittekgolf.com

HAND TOOLS



▶ SOIL PROFILE SAMPLER

- Quickly pull a clean root zone sample.
- Check roots in fine turf areas.
- Steel construction. Zinc-plated, case-hardened blade.
- 4"W x 8"H x 3/4"D samples.

#29400ST



▶ TURF DOCTOR

- Invisible sod replacement!
- Finish patch areas without leaving holes or gaps (i.e., irrigation repair).
- Razor-sharp blades (4) secure 9" square-cut, wedge-shaped sod blocks that fit and butt perfectly.

#29200ST



▶ HEXAGON TURF REPAIR TOOL

- Innovative plug design for easy sod/soil removal and seamless replacement.
- Six-sided plugs pull wedges that are 7"W x 4"D.

#29225ST



▶ 8" PRO II HOLE CUTTER / REPAIR TOOL

- Made for installing 8" special event cups, and perfect for quick and easy turf repairs.
- Expeller assembly makes ejecting 8" plugs a breeze, minimizing frustration and wasted time.
- Replaceable 8" inside sharpened shell also available.
- 8" Diameter.

#28785ST - Hole Cutter Straight Inside



▶ HAND AERIFIER

- Choose solid or hollow tines; 2 1/4" penetration.
- Rugged steel construction. Core collector is built right into the base.
- 3" x 3/8" replaceable tines on 2" centers.

#29808ST - Body Assembly Only

#29803ST - Hollow Tine Base Assembly .

#29805ST - Solid Tine Base Assembly



▶ GREENSKEEPER BALL MARK REPAIR TOOL

- Great time-saving, labor-saving tool for quick, near-flawless repairs on greens.
- 36" handle makes repairs fast and easy.
- Meticulously lifts dirt/grass into place in one motion.

#27200ST

THE KLAW

THE KLAW BALL REPAIR TOOL

Finally a ball repair tool that really works! Made primarily of stainless steel this one-action device not only repairs ball marks properly it does it very fast. By pushing down on the handle, two multi prong teeth first project into the turf in a wedge format. As they go deeper the wedge width closes in and finally towards the bottom of the stroke the teeth become parallel. This intricate series of actions pulls the turf towards itself lifting it back into place. Final tamping completes the repair.

The Klaw performs the most frequently recommended motion to repair ball marks. Repair speed is estimated between 15 - 20 in about two minutes. Great for weaving plugs back into green.

30" H x 4.5" x 3.5"
4 lbs.

#G560 - Klaw

#G560RK - Repair Kit



Order online 24/7 @ www.wittekgolf.com

TRIMMERS



▶ TURBOTRIM HEAD TRIMMER

The only trimmer with a forward and reverse drive ratchet mechanism

- Super heavy-duty steel construction w/ powder-coated finish
- Comfortable rubber handle grips
- Interchangeable cutting blades to match your sprinkler model

#TTRC-007 - 7" TurboTrim Head Trimmer Cutting Blade

#TTRC-008 - 8" TurboTrim Head Trimmer Cutting Blade

#TTRC-100 - TurboTrim Tool w/out Cutting Blade



▶ "POWERHEAD" SPRINKLER HEAD TRIMMER

The "Powerhead" device has to be tried to see how well it works. Simply attaching to the base of all major brand grass trimmer machines, it trims sprinkler heads, irrigation boxes and yardage markers in a flash. With no more strings to contend with, the Powerhead will cut hours off your trimming. Please indicate make and model of your trimmer machine. This product comes in four sizes.

#400770 - 6" (Toro 630/730/760)

#400771 - 6½" (Hunter/Legacy 520)

#400772 - 7½" (Toro 650 / 655 / 670 / 780)

#400773 - 10" (Toro 690/Rainbird, 91DR Rainbird, 91DS/10" Valve Box)



▶ TAS HEAD TRIMMER

Made from heavy duty steel, these head trimmers are fast and efficient. Ideal for sprinkler heads, control valve covers, etc. Sizes span from 3 3/4" to 10 1/4" diameters and are designed to fit all major brands of trimmer machines.

* If installing on Echo equipment, when placing your order please remember that a steel spacer is needed.

* Brush cutter blade adapter kit needed, not included.

#400760 - 3¾" Diameter

#400761 - 5½" Diameter

#400762 - 7" Diameter.

#400763 - 7½" Diameter

#400764 - 8" Diameter

#400765 - 8½" Diameter .

#400766 - 10" Diameter

RAKES & GAUGES



▶ LEAF RAKE

A basic but essential rake, with a heavy duty 19" wood handle. Perfect for any and every maintenance project. 67"L x 23½"H (2.4 lbs.).

#400701 - 19"



▶ SPRING BACK RAKE

AA heavier duty rake for your grounds crew's toughest projects. A longer, 24" wood handle to make cleanup a breeze. 63"L x 20¼"H (1.9 lbs.).

#400700 - 24"



▶ DEBRIS RAKE

This well known multi-purpose maintenance rake comprises tempered spring steel wire teeth mounted on a durable plastic head, handle is 60" heavy-duty fiberglass. The rake is ideal for removing debris from bunkers particularly pine needles, and final finishing of bunker sand 21"L x 60"H (7 lbs.).

#400233



▶ ROLLER SQUEEGEE

High strength double-ribbed aluminum channel. Corrosion resistant material. Durable closed cell foam rubber roller and completely watertight assembly. Roller hub made of industrial grade bearing material. Stainless steel axle. Solid reinforced end bracket. 57½" handle.

#71324ST - 24"
#71336ST - 36"
#71348ST - 48"



▶ LEVELAWN

- Distributes application materials.
- Removes stones from soil, breaks up small clods of sand or loam.
- Smooths soil for easy planting.

#29300ST - 30" Levelawn
 30"L x 30" W (9.65 lbs.) .
#29375ST - 36" Levelawn
 31"L x 30" W (9.8 lbs.)

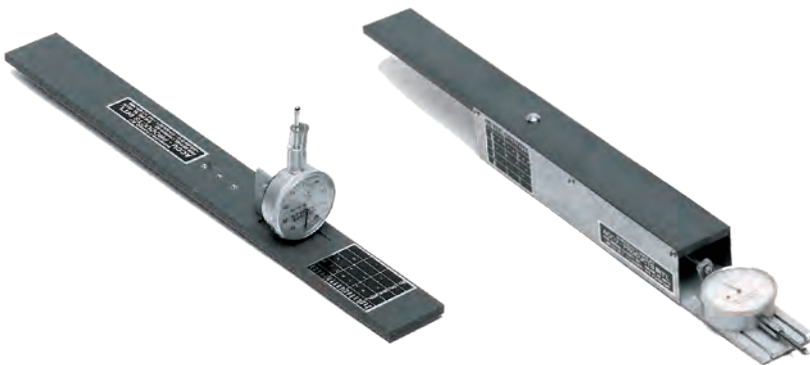

▶ GROOMER GAGE

This is a precision measuring instrument for accurately setting the desired grooming depth of groomer or verticutting units. 24"L (2 lbs.)

#400807

▶ ACCU-GAGE II

This is similar to ACCU-GAGE although it is altered to be used in the field or while units are still attached to mowers. 24"L (2 lbs.)

#400806

▶ ACCU-GAGE

This precision tool is used to set accurate height-of-cut adjustments on greensmowers. Incorporating a dial indicator with adjusting bar apparatus highly accurate measurements can be made at the cutting edge of the bed knife. Measurements read as .001" or 01mm, fits all greensmowers. (1.5 - 2 lbs.)

#400800 - 18" Bar
#400801 - 18" Bar Hands Free.
#400802 - 18" Bar Digital Version
#400803 - 24" Bar

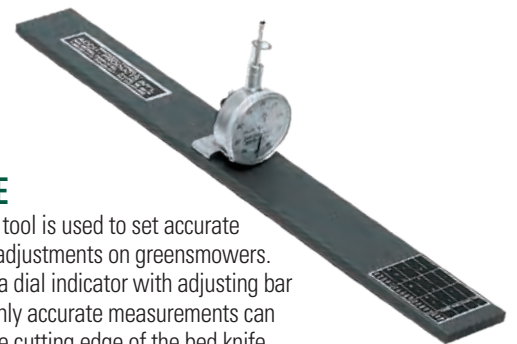

Check your order history @ www.wittekgolf.com

SOIL SURFACTANTS APPLICATORS & IRRIGATION TOOLS

▶ PELLETPRO™ HEAVY-DUTY SURFACTANT APPLICATOR

Our heavy-duty surfactant applicator, high-flow valve and Precision™ Cloudburst™ nozzle combo comprises the finest wetting agent gun available. PelletPro™ accepts all wetting agent tablets and provides a high volume, yet soft spray for watering or applying surfactants to tight, hydrophobic soils.



- 35+ GPM to get the job done faster!
- Ultra Heavy-Duty construction: brass fittings, aircraft aluminum, stainless steel, precision engineered glass.
- Pellet rotation (1 RPS) evenly dissolves/applies tablets.
- Patented Cloudburst™ nozzle delivers large droplets in an outstanding fan pattern.

- #A-PPWA50K-UH - Pellet Pro
- #A-PPB-UH - Bowl Only
- #A-PPBG-UH- Gasket Only
- #400543 - ABS High-Flow 3/4" Valve Full Flow, Oversized Handle

▶ POLYPROPYLENE MEASURING PITCHERS

Made of food grade polypropylene, these pitchers are resistant to most agricultural chemicals. Thick walled and easy to handle for excellent controlled pouring. Measurement graduations in US fluid oz. and mils.



#406640	8 oz. Pitcher
#406641	16 oz. Pitcher
#406642	32 oz. Pitcher
#406643	64 oz. Pitcher
#406644	128 oz. Pitcher

▶ MULTI-PURPOSE TOOL AND KEYS



- #A-SKTRB-UH - Super Key XL
- #406631 - Rainbird Easyreach Key
- #406632 - Toro Easyreach Key

▶ GULP™ ULTRAMAX SUPER HIGH-CAPACITY WATER REMOVAL SUCTION PUMPS

- Super smooth pumping action.
- High volume capacity.
- Strong aluminum pump shaft.
- Contour grip handle.
- No leak seals.
- Self priming.
- Gulp & Big Gulp has easy push button cleaning system along with included debris filter attachment.



▶ **BIG GULP ULTRAMAX**
 35 oz. / stroke
 36" pump chamber
 72" or 36" outlet hose
#A-G3672-CK-UH



▶ **GULP ULTRAMAX**
 18 oz. / stroke
 14" clear pump chamber
 18" outlet hose
#A-G12-C-UH



▶ **GULP SYRINGE ULTRA**
 12 oz. / stroke
 12" pump chamber
#A-G125-C-UH

FINALLY THE RIGHT LENGTH HOSE FOR THE RIGHT JOB!

▶ **SHORTY PRO™**

- Ideal for quick green, tee syringing without extra hose to carry around
- Ideal for equipment wash-down
- Rated to 1200 Psi Burst Pressure



#H75-S10-UH	¾" x 10'
#H75-S20-UH	¾" x 20'
#H10-S10-UH	1" x 10'
#H10-S20-UH	1" x 20'

▶ **ULTRA MAX GREEN HOSE**

Superintendents' favorite for years. This hose offers 800PSI burst strength with 200 PSI WP.



#H75-050G-UH	¾" x 50'
#H75-075G-UH	¾" x 75'
#H75-100G-UH	¾" x 100'
#H10-050G-UH	1" x 50'
#H10-075G-UH	1" x 75'
#H15-100G-UH	1" x 100'

▶ **ULTRA MAX BLUE HOSE**

Super lightweight and super strong. This hose offers 1200 PSI burst strength with 300 PSI WP.



#H75-050B-UH	¾" x 50'
#H75-075B-UH	¾" x 75'
#H75-100B-UH	¾" x 100'
#H10-050B-UH	1" x 50'
#H10-075B-UH	1" x 75'
#H15-100B-UH	1" x 100'

▶ **ULTRA MAX RED HOSE**

This hose is the ultimate choice for long life under heavy use. Made of EPDM synthetic rubber and reinforced with spiral synthetic yarn.



#H75-050R-UH	¾" x 50'
#H75-075R-UH	¾" x 75'
#H75-100R-UH	¾" x 100'
#H10-050R-UH	1" x 50'
#H10-075R-UH	1" x 75'
#H15-100R-UH	1" x 100'

▶ **ULTRA MAX CLEAR HOSE**

Lightweight and durable, this hose offers 600 PSI burst strength with 150 PSI WP.



#H75-050C-UH	¾" x 50'
#H75-075C-UH	¾" x 75'
#H75-100C-UH	¾" x 100'
#H10-050C-UH	1" x 50'
#H10-075C-UH	1" x 75'
#H15-100C-UH	1" x 100'

HOSES & IRRIGATION NOZZLES

▶ **PREMIUM HOSE-END NOZZLES & ACCESSORIES**

- Multi-pattern sprays - effortless control with hydraulic assist on/off.
- Solid metal internal - no plastic parts to break or wear out.
- Ratchet mechanism prevents over-tightening damage.
- Ultra-durable construction withstands any abuse.
- Fire hose quality nozzle feels great in your hands.
- Beautiful, consistent spray patterns for life.
- Built for 1" and ¾" flow rates.



#NG-550-DFH-75-UH	Turbo Shift High Flow ¾" 12-43 GPM
#NG-500-SFK-75-UH	Full Throttle High Flow ¾" 15-40 GPM
#NG-550-DFH-10-UH	Turbo Shift High Flow 1" 12-43 GPM
#NG-500-SFH-10-UH	Full Throttle High Flow 1" 15-40 GPM

▶ **DRAINBLASTER™ HIGH PRESSURE DRAIN CLEANING NOZZLE**

This unique hose-end, high pressure nozzle guides itself in cleaning out drains, to remove debris with ease. Special feature includes a wire attachment connector for using wire locator to determine drain route.

Minimum water pressure: 70 PSI

#DN-75-UH	¾" Nozzle
#DN-10-UH	1" Nozzle

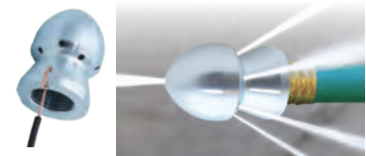

▶ **MULTI PURPOSE ADJUSTABLE NOZZLES**

Made of durable, high strength plastic, these economical nozzles adjust to a variety of sprays.



#406600	¾" Multi Purpose Nozzle
#406601	1" Multi Purpose Nozzle
#406602	¾" Trigger Nozzle

Chat with specialists @ www.wittekgolf.com

COURSE MAINTENANCE ACCESSORIES

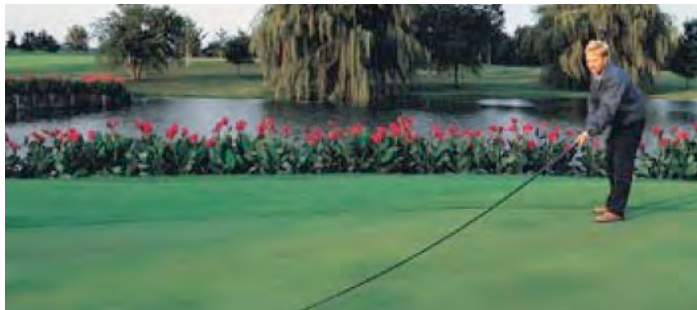

▶ DEW WHIPPING POLE

Fiberglass 2 piece pole with 5/16" single rod taper lock extension.

Sheathed length: 7½ ft. Extended length: 14½ ft.(2.1 lbs.)

#34200ST- Dew Whipping Pole



▶ FAIRWAY SNAKE

The Fairway Snake is lead weighted and has a heavy duty rope that is specifically designed to drag a fairway. The weighted line breaks up grass clippings, reduces disease pressure, and helps to stand up the turf. It is easily pulled using 2 utility vehicles.

#400215 - 100 ft. (50 lbs.)

#400216 - 150 ft. (75 lbs.)

#400217 - 200 ft. (100 lbs.)

#400220 - Reelcraft Reel (50 lbs.)

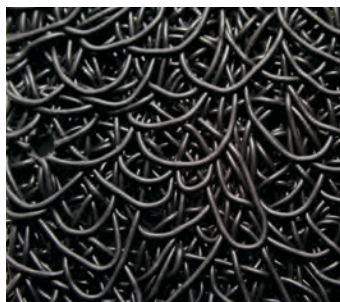

▶ POLY EXTRUDED MATTING

This textured P.V.C. surface provides sure footing - reducing the risk of slipping on bridges, steps and walkways. The material allows moisture to flow through, trims easily with a razor knife and is light weight. It can be adhered to concrete, wood, asphalt or steel with GE 2801 silicone or simply screwed down. Poly extruded matting is easy to clean by sweeping or washing down and can withstand temperature ranges of -35 Degrees to + 180 Degrees F. It resists alkalis, acids, ozone and water borne chemicals.

#400580 - Green, Roll, 3' W x 25' L

#400581 - Black, Roll, 3' W x 25' L

#400582 - Green, Roll, 6' W x 25' L

#400583 - Black, Roll, 6' W x 25' L



▶ ADHESIVES

#400584 - PVC Seam Backing Strip, 100 ft. Roll

#400585 - GE 1800 Silicone, 10.1 oz, Tube

#400586 - Pro Fix 240 Seam Adhesive, 1 lb. Bottle

#400587 - Pro Fix 241 Seam Adhesive Accelerator, 6oz. Can

COURSE MAINTENANCE ACCESSORIES

▶ METAL FLEXIBLE DRAG MAT

These super durable mats are ideal for moving sand and seed. Easy to handle and store. Custom sizes are available.

#400120 - 3' x 5' (27 lbs.)

#400121 - 5' x 5' (45 lbs.)

#400124 - 6' x 7' (73 lbs.)

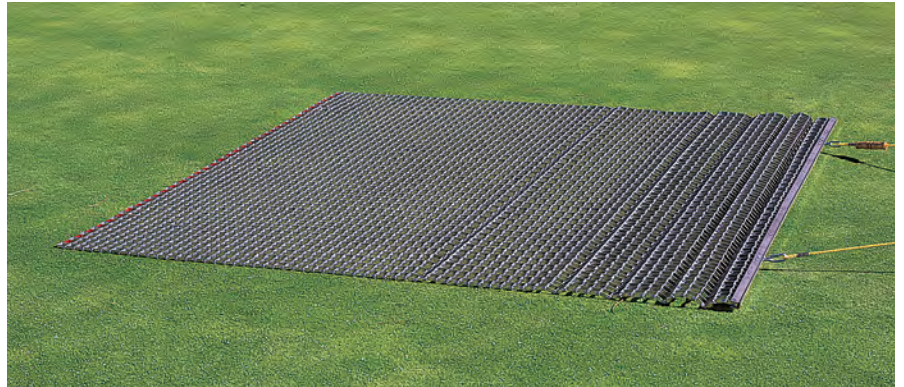

▶ COCO DRAG MAT

A Superintendents' favorite. Made from cocoa fiber and strengthened with a thick plastic backing, this great mat will last many seasons. Absolutely the best mat for protecting your greens when top dressing and filling aerated holes.

#400110 - 4' x 6' (67 lbs.)

#400111 - 5' x 6' (81 lbs.)

#400112 - 6' x 6' (90 lbs.)



▶ Drag Brush

A long-time classic and favorite among superintendents. It gently and evenly works top dressing material into the green and helps control thatch when used before mowing. Extensions are available for bigger jobs. Doubles the length of the brush. Hinged and weighted to help manage contours and uneven areas.

54 1/2"W x 26"H (245 lbs.)

#52000ST - Drag Brush

#52013ST - Replacement 54" Brush Only

27"W x 26"H

#52050ST - Set of Two Extensions

#52063ST - Replacement Brush for Extension

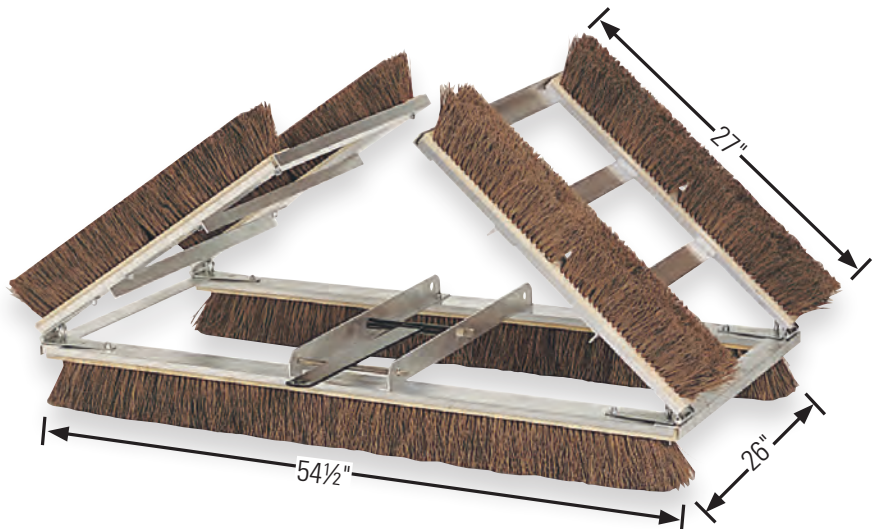

Reorder easily @ www.wittekgolf.com

GOLF CART ACCESSORIES



#93529

► BUGGY COVER 3 X 4

Stay Warm, Dry and Comfortable!

- Designed by PGA Professionals.
- Patented "roll-away" windshield.
- Fits over most rooftop golf cars.
- Folds into convenient nylon carry bag.
- Sets up in seconds with "Jam Cleat" fastening system.
- Made of durable 430 nylon and heavy clear vinyl.
- Size: 58"H x 52"L x 44"W Weight: 10 lbs.

#93523 - Black

#93526 - Forest Green

#93528 - Red

#93529 - Tan

#93533 - Navy Blue

#93540 - Yamaha Drive (specify color)

#93541 - Club Car Precedent (specify color)



#93523



#93528



► KOOLIT COOLERS

A quality cooler for courses that provide beverages for their guests. Soft sided, leak-proof, insulated cooler bag holds up to a 12 pack of can beverages and ice to keep drinks cold for hours. Lightweight, reusable design folds up to 1" thick for compact storage. Easy snap handle. Size: 8"W x 18"H x 6"D (Full). Weight: .36 lb.

#53375 - "Please Return to Clubhouse"

► Golf Cart Towels

Made of terry cloth Available in beige, black and green. Size 15" x 25" 2.50 lbs. (box) No grommet.

#53360 - Beige

#53361 - Black

#53362 - Green



► BUGGY COOLER

Fits any golf cart with a roof top. Attaches in seconds. Holds 18 cans or 12 bottles. The top storage pocket is perfect for sandwiches or snacks. The side pockets store golf balls, tees or cell phones. Includes a hidden drain plug in the bottom of the cooler to drain melted ice.

32"L x 2"W x 14"H Weight: 3 lbs.

#93535 - Buggy Cooler

► PRO RENTAL CART

- Durable and dependable.
- Virtually maintenance free.
- Turf saving 3" wide wheels .
- Cushioned support fits any size bag.
- Removable handle for easy storage.
- Steel ball bearings.
- Weight: 33 lbs./set of 2.

#54006 - Pro Rental Cart, Wide Wheel

#54005 - Pro Rental Cart, Standard Wheel



▶ **CART ID FLAGS**

- Includes clamp so your guests can mark their carts
- ½" stick, 2' long

#401992 - Disabled Player
#401193 - Marshal



▶ **"CLOSEST TO THE PIN" MARKERS**

Made from durable ½" laminated plastic, these proximity markers include a 50' tape measure.

#S304CTP



▶ **CART TOPPERS**

Finally a tournament solution that actually works! Make sure your guests know which cart is theirs, and that you get them out on the course on time. These cart toppers make it easy to make tournaments run smoothly! Available in Black, Blue, Green, Hot Pink, Orange, Purple, Turquoise, Yellow, Red, Lime, White, Tan.

#94405
#94404



▶ **CUSTOM STENCILS**

Create a UNIQUE look to the golf course with these custom cut stencils. Whether it is the club's logo, a special corporate outing, commemorate a special event such as Independence Day, Breast Cancer awareness Month or wedding, we can make the course really stand out. Stencils are custom made and can be sold by themselves or with eco-friendly paint.

Send us your logo and we will do the rest. Our stencil / graphic department crew are experts and are happy to help. No stencil size is too big or too small. No logo is too simple or too complicated. We offer over 100 paint colors. We offer a wide variety of paints that can be used as permanent paints or removable paints or temporary paints for use on natural grass, synthetic turf, asphalt or concrete.

#403300

TOURNAMENT ACCESSORIES



▶ **PROXIMITY MARKERS**

Placed on the tee, fairway or green, these proximity markers can be used to mark hole contests such as "Longest Drive", "Closest to the Pin" and "Longest Putt". Four markers per set. Each set contains: Four markers with pencil holders. Four packs of double-sided cards (25 each) printed with LONG DRIVE on one side and PROXIMITY on the other. Size: 29" x 7½" x 2½". Weight: 6 lbs.

#10700ST - Proximity Marker Set

#10701ST - Replacement Cards (25/per pkg.)

#94406 - Replacement Cards w/Contest Indicator.
5"W x 8"H. (25/per pkg.) Yellow.



▶ **TOURNAMENT STARTER CASE**

A must for all tournament organizers. Perfect for the 1st and 10th tees.

Opens up to feature a bulletin board for posting tee times and rules sheets. Also serves as a central location for tees, pencils, repair tools, etc. Wooden dowel rods act as a paperweight so papers stay organized. Laminated wood grain finish resists scuffs and scrapes. Closes into a convenient storage and carrying case with handle. 4"H x 26¼"W x 17½"D. Weight: 25 lbs.

#68525

Use your terms @ www.wittekgolf.com

PENCILS

▶ **HEX PENCILS** 

Our cedar pencils have a fine grain and a smooth, satiny finish. Traditional 6 sided construction. Available in 8 colors - please specify.

	Black	Blue	Cranberry	Green	Natural	Red	White	Yellow	Length
No Eraser, Plain	#84115	#84118	#84119	#84116	#84120	#84216	#84121	#84316	3½"
No Eraser, Personalized	#84150	#84151	#84152	#84160	#84153	#84170	#84154	#84180	3½"
w/ Eraser, Plain	#84604	#84600	#84605	#84601	#84606	#84602	#84607	#84603	3⅞"
w/ Eraser, Personalized	#84630	#84626	#84631	#84627	#84632	#84628	#84634	#84629	3⅞"

Pencil Custom Imprint Information: Hex Pencil Imprint Area: 2½" x ¼". Maximum 30 characters and spaces per line, up to 3 lines of imprint. No Plate Charge. Minimum Order, Personalized: 20 Gross. \$10 Setup Fee for less than 20 gross. Imprint Colors: Black, Blue, Gold, Green, Maroon, Purple, Red, Silver, White, Yellow.

▶ **ROUND PENCILS** 

Ideal for imprinting your logo. Featuring soft feel and exceptionally smooth paint coatings. Available in 8 colors - please specify.

	Black	Blue	Cranberry	Green	Natural	Red	White	Yellow	Length
No Eraser, Plain	#84670	#84671	#84672	#84673	#84674	#84675	#84676	#84677	3½"
No Eraser, Personalized	#84680	#84681	#84682	#84683	#84684	#84685	#84686	#84687	3½"
w/ Eraser, Plain	#84640	#84641	#84642	#84643	#84644	#84645	#84646	#84647	3⅞"
w/ Eraser, Personalized	#84660	#84661	#84662	#84663	#84664	#84665	#84666	#84667	3⅞"

Pencil Custom Imprint Information: Round Pencil Imprint Area: 2½" x ¼". Logo and 2-3 lines of imprint on Round Pencils Only: \$15.00 Screen Charge Each Order. Minimum Order, Personalized: 20 Gross. \$10 Setup Fee for less than 20 gross. Imprint Colors: Black, Blue, Gold, Green, Maroon, Purple, Red, Silver, White, Yellow

TEES

BAMBOO TEES

Are a sustainable and environmentally friendly alternative to plastic golf tees. 10,000 Tees per carton.

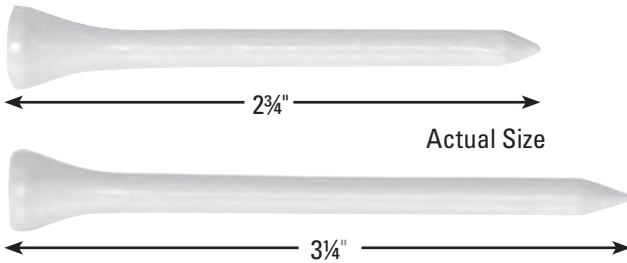

Color	2 3/4"	2 3/4" (per bag)	3 1/4"
White	#92620	#92630	#92603
Natural	#92621	#92631	#92604

DELUXE TEES

Feature the proslim shank measuring .171 in diameter. Available in 11 Stock Colors: Mixed, Natural, White.

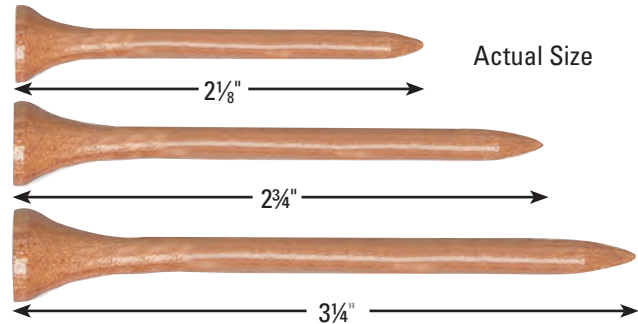

Color	2 1/8" (10M) 15 Per Bag	2 3/4" (10M) 15 Per Bag	3 1/4" (7.5M) 15 Per Bag
White	#92815	#92915	#92820
Mixed	#92816	#92916	#92821
Natural	#92817	#92917	#92822

Color	2 1/8" (10M) BULK	2 3/4" (10M) BULK	3 1/4" (7.5M) BULK
White	#92805	#92807	#92810
Natural	#92803	#92808	#92811
Mixed	#92804	#92806	#92809

PRO SHOP PACKAGING

- #92875 - 2 1/8" ShorTee - 25 per bag
 - #92876 - 2 3/4" ProLength - 20 per bag
 - #92877 - 3 1/4" ProLength-Plus - 15 per bag
 - #92878 - 4" Prolength-Max - 12 per bag
- 200 bags per carton

RETAIL PACKAGING

- #92883 - 2 1/8" ShorTee - 120 per bag
 - #92884 - 2 3/4" ProLength - 100 per bag
 - #92885 - 3 1/4" ProLength-Plus - 75 per bag
 - #92886 - 4" Prolength-Max - 50 per bag
- 12 bags per carton

PERSONALIZED TEES

Please specify tee color and imprint color when ordering.

- #92500 - 2 1/8" Tee
- #92501 - 2 3/4", Tee
- #92502 - 3 1/4", Tee

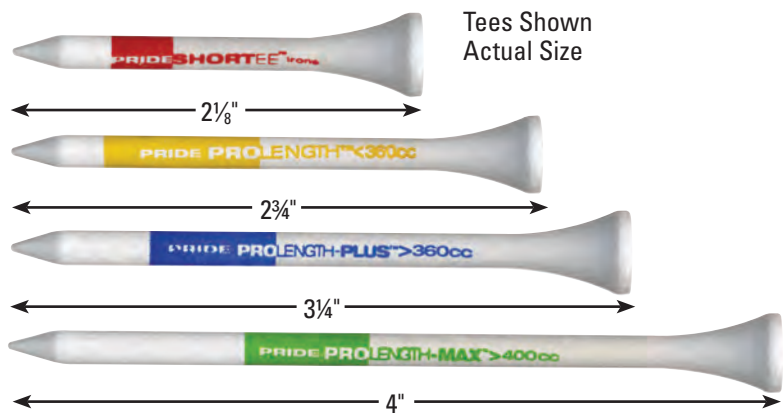

See your invoices/statements @ www.wittekgolf.com

DIVOT REPAIR TOOLS



▶ CUSTOM EMBOSSED DIVOT REPAIR TOOL

Imprint area: 1 1/8" x 1/2"
Minimum quantity: 1,000

- #91290 - Gold
- #91291 - Silver
- #91292 - Pewter
- #91293 - Antique Brass
- #91294 - Antique Copper

BALL MARKERS



▶ PLASTIC BALL MARKERS & QUARTERMARKS®

Molded from high impact plastic.
Sold in quantities of 1,000.

Plain - Assorted or neon color only.

Personalized - Specify color of marker and color of imprint.

- | | |
|--------|---------------------------|
| #91266 | Plain Dime Markers |
| #91267 | Personalized Dime Markers |
| #91268 | Plain QuarterMarks |
| #91269 | Personalized QuarterMarks |



▶ FLIX DIVOT REPAIR TOOLS

Switchblade action and a soft feel finish along with stainless steel forks sets this Divot tool apart from the competition. The Flix Lite comes with a magnetic ball marker that can be customized with a full color resin domed logo. The Flix Lite DS features two unique branding locations. Free custom display with an order of 50 pcs and no artwork setup charge for either tools! Colors for Flix Lite: Lime Green, Red, Blue, Orange, Black. Flix Lite DS colors: Blue, Black, Red, White.

#FXLT - Flix Lite w/ Custom Logo Marker

#FXDS - Flix Lite DS w/ Custom Logo on back and Marker



▶ DELUXE REPAIR TOOL

Our premium divot repair tools are available in 25 vibrant colors, including neon. Please specify when ordering.

#91250 - Plain - Assorted or specific color only

#91251 - Personalized - Assorted or specific color only

BAG & CART TAGS

Made of unbreakable plastic, Bag and Cart Tags can be customized with your course name and logo or personalized for any event.



#93301
Rectangle Bag Tag



#93302
Square Bag Tag



#93303
Diamond Bag Tag



#93304
Jumbo Tag



#93305
Guest Bag Tag



#93306
Rounded Diamond Bag Tag



#93307
Round Bag Tag



#93308
Oval Bag Tag



#93310
Cart Tag

▶ CLEATKADDY® AND DRILL BITS

Now it's more convenient than ever before to install alternative golf cleats. Made of rugged reinforced plastic.

#93997



▶ MULTI WRENCH KIT

In the past worn cleats have been difficult to remove, but thanks to Softspikes Cleat Ripper cleat changing is now easier than ever. Tune-up your game by changing your cleats.

#93996



REPLACEMENT CLEATS

PULSAR™



Product Description



Kits

#92455

#92470

400ct Bowl

#92465

#92472

BLACH WIDOW™



Product Description



Kits

#92310

#92315

#92320

400ct Bowl

#92334

#92335

#92321

Order online 24/7 @ www.wittekgolf.com

REPAIR ACCESSORIES & TOOLS

▶ ALL-AMERICAN JUNIOR SETS SL500 CLUBS

Featuring oversized titanium alloy woods and die cast perimeter flow weighted oversized irons with steel shafts.

JUNIOR 5 PIECE SETS

Includes #1 Wood, #5 Hybrid, 7, 9 Iron and Putter. Weight: 6 lbs.

#95115 - Right Hand

#95116 - Left Hand

JUNIOR 7 PIECE SETS

Includes #1 Wood, #3 Wood, #5 Hybrid, 7, 9 Iron Sand Wedge and Putter. Weight: 8 lbs.

#95117 - Right Hand

#95118 - Left Hand

Club	(RH)	(LH)
#1 Wood	#95525	#95625
#3 Wood	#95526	#95626
Hybrid	#21205D	#51805D
#5 Iron	#95530	#95630
#7 Iron	#95532	#95632
#9 Iron	#95534	#95634



▶ RITE ON WEDGES

These wedges were especially designed for versatility whether you're playing from grass, rough, or sand. Weight: 1 lb.

#95836 - 52° A Wedge - Right Handed

#95837 - 56° Sand Wedge - Right Handed

#95838 - 60° Lob Wedge - Right Handed

Please Call For Left Handed



▶ HOOK BLADE KNIFE

#90763 - Hook Blade Knife

#90764 - Replacement Blade (5 pack)



▶ GO-GETTER BALL RETRIEVERS

Popular hinged cup design. Extends to 12' length.

#93830



▶ REGRIPPING TAPE

A must for all regrippers!

#90725 - Lead Tape - 3/4" x 45"

#90730 - Two Way Tape - 3/4" x 108"

#90735 - Two Way Tape - 1" x 108"

#90740 - Two Way Tape - 2" x 108"

RENTAL CLUBS

▶ SL500 CLUBS – TITANIUM ALLOY WOODS & ZINC ALLOY IRONS.

Flow weighting system combines perimeter weighting with peripheral weighting to insure that each club head is weighted optimally for its specific purpose. Right and Left Hand available. Set includes 2 Woods (1 & 3), 1 Hybrid (#3/4), 6 Irons (5-9, PW) and Putter. Weight: 12 lbs.

#95253 - Men's Right Hand #95255 - Women's Right Hand
 #95254 - Men's Left Hand #95256 - Women's Left Hand

Club	Men's (RH)	Men's (LH)	Women's (RH)	Women's (LH)
#1 Wood	#95125	#95225	#95325	#95425
#3 Wood	#95126	#95226	#95326	#95426
Hybrid	#51034D	#81034D	#61034D	#91034D
#3 Iron	#95128	#95228	#95328	#95428
#4 Iron	#95129	#95229	#95329	#95429
#5 Iron	#95130	#95230	#95330	#95430
#6 Iron	#95131	#95231	#95331	#95431
#7 Iron	#95132	#95232	#95332	#95432
#8 Iron	#95133	#95233	#95333	#95433
#9 Iron	#95134	#95234	#95334	#95434
#PW	#95135	#95235	#95335	#95435



▶ SHOT CONTROL PUTTERS

These stainless steel putters feature great sight lines for alignment. Available in four head designs. One left hand style available. 34" steel shaft. Weight: 1 lb.



#95915

#95916

#95917

#95918

#95919

Left Hand

▶ HF-100 ADVANCE GRIP TAPE ACTIVATOR

"The Grip Solution" works with any double sided grip tape. It is non-toxic, non-flammable, odorless, reusable, and easy to clean up. It greatly reduces the amount of solution used by 60%. Playable in 10-15 minutes. Available in quarts or gallons. Spray pump sold separately.



#90750 - Quart.
 #90752 - Gallon
 #90751 - Pump Spray for quart



▶ GRIP REMOVER GUN WITH NEEDLE & ADAPTER

#90483



▶ GRIP REMOVER NEEDLES

Pack of 12

#90773

Check your order history @ www.wittekgolf.com

GOLF GRIPS

▶ EXCEL SOFTGRIP



Code	Color	Size	Core	Weight
#90379	Black	Standard	.600 (Rnd)	42g
#90382	Black	Oversize	.600 (Rnd)	47g

▶ DRI-TAC GRIP
WinnDry Technology

Code	Color	Size	Core	Weight
#90675	Pink/Gray	Undersize	.590 (Rnd)	35g
#90585	Gray	Undersize	.590 (Rnd)	35g
#90586	Dark Gray	Standard	.600 (Rnd)	48g
#90588	Dark Gray	Midsize	.600 (Rnd)	49g
#90116	Navy Blue	Midsize	.600 (Rnd)	49g
#90589	Black/Blue	Midsize	.600 (Rnd)	49g
#90590	Dark Gray	Oversize	.590 (Rnd)	50g



▶ TOUR CLASSIC PUTTER GRIP

Midsize - .580 Round - Buffed Rubber - 84g
#90351 - Black/White Logo



▶ SUPERSTROKE GRIPS

The SuperStroke putter grip series are widely popular among golfers. The no-taper technology has helped millions of golfers achieve a more consistent stroke. Available in UltraSlim 1.0, Midslim 2.0, Slim 3.0 and Fatso 5.0 series in a variety of colors.

GRIPS BY GOLF PRIDE

▶ TOUR VELVET STYLES GRIP

Buffed Rubber



#90321

▶ TOUR WRAP 2G GRIP

Rubber Seamless



#90487

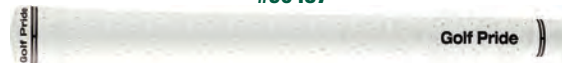

#90492

▶ MULTI-COMPOUND GRIP

Cord Rubber



#90300



#90301



#90302



#90303

▶ MCC PLUS 4 GRIP

Cord Rubber



#90003



#90002



#90001

▶ CP 2



Pro



Wrap

▶ MCC ALIGN



▶ TOUR VELVET ALIGN



Code	Color	Size	Core	Weight
#90325	Black/White Logo	Standard	.580 (Rnd)	51.5g
#90324	Black/White Logo	Standard	.580 (Rib)	51.5g
#90327	Black/White Logo	Standard	.600 (Rnd)	49.5g
#90326	Black/White Logo	Standard	.600 (Rib)	49.5g
#90329	Black/White Logo	Midsize	.600 (Rnd)	53.5g
#90330	Black/White Logo	Jumbo	.600 (Rnd)	61g

Code	Color	Size	Core	Weight
#90488	Black/White Logo	Standard	.580 (Rnd)	50g
#90489	Black/White Logo	Standard	.600 (Rnd)	48g
#90490	Black/White Logo	Midsize	.600 (Rnd)	58g
#90491	Black/White Logo	Jumbo	.600 (Rnd)	73g
#90492	White/Black Logo	Standard	.600 (Rnd)	55g

Code	Color	Size	Core	Weight
#90300	Red/Black	Standard	.600 (Rnd)	46.5g
#90301	White/Black	Standard	.600 (Rnd)	46.5g
#90303	Blue/Black	Standard	.600 (Rnd)	46.5g
#90302	Yellow/Black	Standard	.600 (Rnd)	46.5g
#90652	Black/Black	Standard	.600 (Rnd)	46.5g

Code	Color	Size	Core	Weight
90001	Black/Blue	Standard	.600 (Rnd)	52g
90002	Black/Red	Standard	.600 (Rnd)	52g
90003	Black/Grey	Standard	.600 (Rnd)	52g
90004	Black/Grey	Midsize	.600 (Rnd)	66g

Code	Color	Size	Core	Weight
90109	Black/Blue	Standard	.600 (Rnd)	51g
90110	Black/Blue	Midsize	.600 (Rnd)	64g
90106	Black/Red	Standard	.600 (Rnd)	51g
90107	Black/Red	Midsize	.600 (Rnd)	64g

Code	Color	Size	Core	Weight
90383	Black/White	Standard	.600 (Rib)	51g
90384	Black/White	Midsize	.600 (Rib)	62g

Code	Color	Size	Core	Weight
90178	Black/Red	Standard	.600 (Rib)	51g

Chat with specialists @ www.wittekgolf.com

MINIATURE PUTTERS

▶ BLACK LIGHT PUTTERS

Add cool colors to your Black Light course. Urethane heads are combined with a matching grip to complete the putter.

- Glows under Black Light.
- Four colors to choose from.

Available in 37", 35", 31" and 27".

Custom lengths available.

Colors: Orange, Yellow, Pink, and Green.

Weight: 1 lb.



Color	37"	35"	31"	27"
Orange	#83837	#83835	#83831	#83827
Yellow	#81537	#83935	#83931	#83927
Pink	#84137	#84135	#84131	#84127
Green	#84037	#84035	#84031	#84027

▶ TRADITIONAL PUTTERS

Our chrome and silver satin putters offer long life and a classic design.

- Double sided putter heads for right and left handed players.
- Made of durable die cast heads with extra thick hosel walls.
- Stainless steel step-down shafts.
- Custom designed grips with molded plastic butt cap for longer wear.
- Weight: 1 lb.

	Model	37"	35"	31"	27"
(A)	Chrome End Shaft	#81137	#81135	#81131	#81127
(B)	Silver Satin	#81237	#81235	#81231	#81227
(C)	Chrome Center Shaft	#81437	#81435	#81431	#81427



(A)

(B)

(C)



▶ SAFE-T PUTTERS

The popular putters that everyone loves! Softer head reduces the damage to fairway carpet, landscaping, and obstacles.

Weight: 1 lb.

- The most durable putters on the market.
- They pay for themselves in terms of preventing injury to players.
- Enjoy insurance premium reductions with the use of Safe-T Putters throughout your course.
- Designed of "soft touch" Nitrile rubber molded around entire blade.
- Specially weighted to industry standards.
- Available in 37", 35", 31" and 27".
- Sizes from Kids to Adults.

Color	37"	35"	31"	27"
Orange	#81737	#81735	#81731	#81727
Purple	#81537	#81535	#81531	#81527
Blue	#82337	#82335	#82331	#82327
Green	#82037	#82035	#82031	#82027
Yellow	#81637	#81635	#81631	#81627
Pink	#81837	#81835	#81831	#81827
Black	#82537	#82535	#82531	#82527
Red	#81937	#81935	#81931	#81927



▶ URETHANE PUTTERS

This stylish Urethane Putter is the newest addition to the Wittek putter line.

Weight: 1 lb.

- Durable yet still softer than metal putters.
- Bull's eye and aiming line on the head.
- Available in 8 exciting colors.
- Sizes from Kids to Adults.
- Available in 37", 35", 31" and 27" Weight: 1 lb.

Color	37"	35"	31"	27"
Orange	#83337	#83335	#83331	#83327
Purple	#83537	#83535	#83531	#83527
Blue	#83137	#83135	#83131	#83127
Green	#83237	#83235	#83231	#83227
Yellow	#83737	#83735	#83731	#83727
Pink	#83437	#83435	#83431	#83427
Black	#83037	#83035	#83031	#83027
Red	#83637	#83635	#83631	#83627

Reorder easily @ www.wittek-golf.com

ACCESSORIES

▶ REPLACEMENT GRIPS

Specially designed for commercial use. Grips feature a custom designed butt cap made of durable plastic molded to the grip. A metal washer is molded into every cap for added strength.

#83100 - Black #83425 - Orange
 #83200 - Blue #83450 - Purple
 #83300 - Red #83475 - Pink
 #83400 - Green #83500 - Yellow



2 metal washers are in the end of the putter shaft/grip. One is molded into the cap, the other is placed on the shaft end for added strength and durability. This withstands the abuse or constant tapping and pounding.



▶ JUNIOR PUTTERS IN PLASTIC

Lightweight design is ideal for small children.

- Made of solid polyethylene.
- Double sided putter head, for right and left handed players.

Colors: Green, Red, Blue. 19" long.

#81150 - Green
 #81151 - Red
 #81152 - Blue



▶ KIDS PUTTER HOLDER

16"W x 16"D x 16"H.

Holds 64 putters.

Weight: 13 lbs.

#81175 - Black
 #81176 - Green



▶ ADULT PUTTER HOLDER

14"W x 14"D x 31"H.

Holds 64 putters.

Weight: 17 lbs.

#81180 - Black
 #81181 - Green



▶ MINIATURE GOLF SCORECARDS

Made of heavy card stock paper. Cards are scored in the center for easy folding. Sold 1000/package. 4" W x 8.5"L. Weight: 7 lbs. #84114 - Scorecards

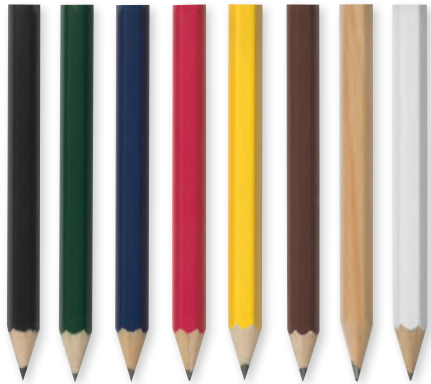

▶ PENCILS

Our Hex pencils are the standard of the industry. 8 available colors. 3½" long. Sold per gross (144 pencils). Weight: ¾ lb./gross.

- #84115 - Black
- #84116 - Green
- #84118 - Blue
- #84216 - Red
- #84316 - Yellow
- #84119 - Cranberry
- #84120 - Natural
- #84121 - White



▶ PERSONALIZED HEX PENCILS

A great way to advertise your miniature golf course or family fun center! Up to 3 lines of print. 8 available colors. Engraving Colors: Black, White, Metallic Gold, Silver, Blue, Green, Red. Specify when ordering. Allow 2 weeks for delivery. 3½" long. Sold per gross (144 pencils). Weight: ¾ lb./gross. 10 Gross minimum. 20+ Gross order - No set up charge. 10 Gross order - \$10.00 set up fee.

- #84150 - Black
- #84160 - Green
- #84151 - Blue
- #84170 - Red
- #84180 - Yellow
- #84152 - Cranberry
- #84153 - Natural
- #84154 - White



▶ GOLF BALL COUNTER DISPLAY

A clever and convenient way to display your miniature golf balls! White golf ball is made of high density polyethylene and sits on a 12" wide metal base. Holds up to 12 dozen balls. 12" dia. x 12"H Weight: 3 lbs. Golf balls not included. #64695 - Counter Display



▶ MINIATURE GOLF BALL VENDOR

Ideal for countertops or hanging on a wall. Durable yellow coating for long lasting wear. Ten columns hold a total of 110 golf balls. 10½" W x 19"H x 5"D. Weight: 4 lbs. Golf balls not included. #84500 - Ball Vendor

Use your terms @ www.wittekgolf.com

MINIATURE GOLF BALLS

▶ 2-PIECE MINIATURE BALLS

Wittek offers the widest selection of quality Miniature Golf Balls in the industry... neons, pastels and originals in a rainbow of fun colors! Featuring Surlyn covered, two piece construction. Sold in dozens. Shipping Weight: Golf balls weigh 1lb./dozen.

▶ FLOATER MINIATURE BALLS

We're not kidding when we say our balls rise to the top over the others, after all, they're Floater Balls! Our unsinkable favorites are available in every color. Sold in dozens."

Shipping Weight: Golf balls weigh 1 lb./dozen.

	Original 2-Piece Solid Color Balls	Floater Solid Color Balls
Blue	#82115	#82215
Green	#82116	#82216
Orange	#82117	#82217
Red	#82118	#82218
Yellow	#82119	#82219
Black	#82133	#82233
Purple	#82134	#82234
Neon Green	#82121	#82221
Neon Orange	#82122	#82222
Neon Pink	#82123	#82223
Neon Yellow	#82124	#82224
Pastel Blue	#82126	#82226
Pastel Green	#82127	#82227
Pastel Pink	#82129	#82229
Pastel Lavender	#82130	#82230
White	#82135	

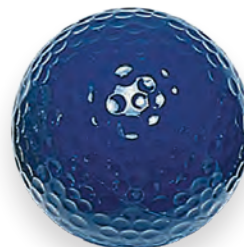

Blue



Green



Orange



Red



White



Yellow



Black



Purple



Neon Green

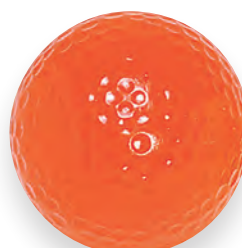

Neon Orange



Neon Pink



Neon Yellow



Pastel Blue

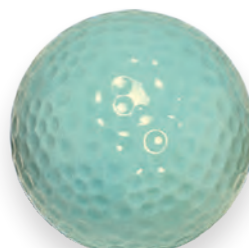

Pastel Green



Pastel Pink



Pastel Lavender

NOVELTY GOLF BALLS

▶ EMOJI BALLS

Sold as a set.

#82196

Shipping Weight: Golf balls weigh 1 lb./Dz.



▶ BLACK LIGHT BALLS

Add more colors to your Black Light course.

- Glows under Black Light.
- Five colors to choose from.

Colors: Green, Orange, Pink, Yellow, and White.

Weight: 1 lb./Dz.

Neon Green	#82121
Neon Orange	#82122
Neon Pink	#82123
Neon Yellow	#82124
White	#82125



▶ GALACTIC NOVELTY BALLS

Sold as a set.

Shipping Weight:

Golf balls weigh 1 lb./Dz.

#82197



▶ 2-PIECE NOVELTY MINIATURE BALLS

Shipping Weight: Golf balls weigh 1lb./Dz.



See your invoices/statements @ www.wittekgolf.com

CARPETING



▶ DELUXE TURF

One of our best sellers! Made for courses with moderate to heavy traffic. Five year limited fade warranty. Pile height: ½". Face weight: 24 oz./sq.yd. Backing: ActionBac. Color: Palm Green.

#86301 - Deluxe Turf, 12' x 100' Roll, Weight: 500 lbs.

#86302 - Deluxe Turf, Cut Roll, 12' Wide.



▶ ONE PUTT

Tufted, non-directional turf is made of 100% Olefin Face Fiber. Ideal for moderate to heavy traffic. Five year limited warranty against discoloration and ultraviolet degradation. Backing: All-weather Unitary Back. Color: Winter Green. F.O.B. Origin.

#86113 - One Putt, 12' x 100' Roll, Weight: 400 lbs.

#86114 - One Putt, Cut Roll, 12' Wide.



▶ DURA PUTT

Constructed with the highest UV protected olefin turf, Dura Putt is the most durable. Resistant to stains, mildew and degradation due to sunlight. Seven year limited warranty.

All-weather Unitary Back. Color: Lawn Green. F.O.B. Origin.

#86120 - Dura Putt, 12' x 100' Roll, Weight: 460 lbs.

#86121 - Dura Putt, Cut Roll, 12' Wide.

▶ TEE OFF PADS

Our durable pads are designed for high volume commercial use. For right and left handed players.

▶ NEW COLORED GRASS TEE OFF PADS

Raised holes make it easier for kids to play. 12"x 12". Available in 6 colors.

Weight: 0.80 lb.

#84403 - Blue

#84404 - Green

#84405 - Orange

#84406 - Red

#84407 - Yellow

#84408 - Black

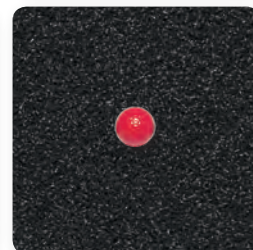
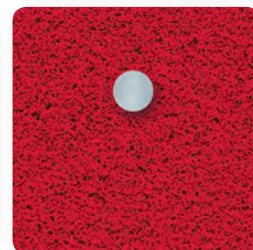
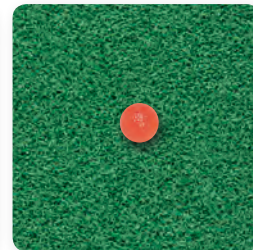
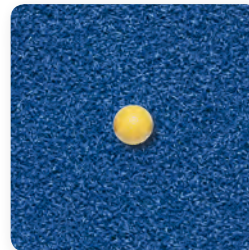

▶ RUBBER

Our heavy duty rubber pads will last season after season. Weather resistant. Available in two sizes.

#84401 - Rubber Tee Off Pad.

11½"W x 11½"L x 1/8" thick. Weight: 1 lb.

#84402 - Jumbo Rubber Tee Off Pad.

36"W x 24"L x 1/8" thick. Weight: 6 ½ lbs.



SIGNS & HOLDERS

▶ MINI INFO SIGN HOLDERS

Our popular sign holders are used to keep players informed on rules as well as course events. Signs can be easily changed when needed. Each holder uses two signs or one sign and one clock. Ultra strong polyethylene construction. Designed for durability. Order signs separately. Size: 18½"W x 29"H. Weight: 16 lbs.

#77285 – Mini Info Sign Holder, Black

#77286 – Mini Info Sign Holder, Green

#77322 – Clock only



▶ INDIVIDUAL MINI GOLF SIGNS

Nine different popular signs. All signs are single sided and made from durable styrene. Order sign holder separately. Size: 14½"W x 13"H. Weight: .40 lb.



#81190



#81191



#81192



#81193



#81194



#81195



#81196



#81197



#81198

Order online 24/7 @ www.wittekgolf.com

PICKERS

Range Rover

Draw Bar Parts List

#71770	Coupler for Front Section
#71776	Coupler Repair Kit to fit 2" Ball
#71798	Ball Hitch 2" Diameter
#71854	Range Rover Draw Bar
#71936	Swivel/Caster Fork
#71937	Axle for Front Wheel
#71946	12" Long Post Assembly
#71950	Front Wheel Sealed Bearings
#71969	Range Rover Push Bar
#71976	Vehicle Attachment Bar
#71981	7-1/4" Connecting Rod
#71985	5-15/16" Post Assembly Rod
#71989	Wheel/Tire with Bearings

Drum Section Parts List

#71801	3/4" Pillow Block Bearing
#71805	3/4" Axle for 3-5 Gang Drum
#71808	Tire only for Drum
#71857	Range Rover Front Frame
#71912	Plastic Picker Basket
#71916	Drum Section End Plate
#71919	3/8" Tie Rod
#71920	3' Black Drum Section (with end tires)
#71920W	3' White Drum Section (with end tires)
#71932	Disc Only - Black
#71932W	Disc Only - White
#71939	Range Rover Side Frames
#71959	Drum Section End Spacer
#71978	Wheel Only for Drum Section
#71984	Retaining Pin

2000 To Current SL90

Draw Bar Parts List

#71715	Small Swivel & Caster Fork
#71725	Small Front Wheel, Tire, Tube, and Axle
#71790	Axle for Small Front Wheel
#71794	Bearings for 2000 Small Front Wheel
#71813	Right SL90 Outrigger Bar Only
#71814	Left SL90 Outrigger Bar Only
#71815	SL90 Junior Draw Bar Only
#71816	SL90 Senior Draw Bar Only
#71817	SL90 Deflector with Rod
#71817R	SL90 Deflector with Round Rod
#71936	SL90 Swivel Caster Fork
#71937	SL90 Axle for Front Wheel
#71967	3/4" SL90/BH Bearing
#71989	Front Wheel/Tire with Bearings

Drum Section Parts List

#71801	3/4" Pillow Block Bearing
#71805	3/4" Axle for 3-5 Gang
#71808	Tire Only for Drum Section
#71821	SL90 Frame Only
#71912	Plastic Picker Basket
#71916	Drum Section End Plate
#71919	Tie Rod 3/8"
#71920	3' Black Drum Section (with end tires)
#71920W	3' White Drum Section (with end tires)
#71959	Drum Section End Spacer
#71932	Disc Only - Black
#71932W	Disc Only - White
#71978	Wheel Only for Drum Section
#71984	Retaining Pin



2000 To Current Ball Hawk LT

Draw Bar Parts List

#71715	Single Section Swivel & Caster Fork (5ft.)
#71725	Small Front Wheel, Complete
#71790	Axle for Small Front Wheel (5ft.)
#71794	Small Front Wheel Bearing (5ft.)
#71940	Articulating Elbow
#71941	7-1/2" Front Wheel Axle
#71946	12" Long Post Assembly for 3-5 Gang
#71950	Front Wheel Sealed Bearings
#71967	3/4" SL90/B.H. Bearing
#71968A	Ball Hawk Draw Bar
#71969	Ball Hawk Push Bar
#71976	Ball Hawk Vehicle Attachment Bar
#71979	Ball Hawk Caster Fork Complete
#71981	7-1/4" Connection Rod
#71985	5-1/2" Extension Rod Only
#71989	Wheel/Tire with Bearing for 3-5 Gang

Drum Section Parts List

#71801	3/4" Pillow Block Bearing
#71805	3/4" Axle for 3-5 Gang
#71808	3/4" Tire Only for Drum
#71912	Plastic Picker Basket
#71916	Drum Section End Plate
#71919	Tie Rod 3/8"
#71920	3' Black Drum Section (with end tires)
#71920W	3' Black White Section (with end tires)
#71932	Disc Only - Black
#71932W	Disc Only - White
#71939	3-5 Gang Frame Only
#71959	Drum Section End Spacer
#71978	Wheel Only for Drum Section
#71984	Retaining Pin

Eagle Lite

#71922	Black Drum Set (includes axle bracket set)
#71923	White Drum Set (includes axle bracket set)
#WGRM036	Disc Only - Black
#WGRM037	Disc Only - White
#71760	Adjustable Drum Brackets (set)
#71761	Front Post Assembly
#71762	Back Post Assembly
#71763	Front Wheel Package

PICKERS



Commercial Tire Picker

#71710	Large Swivel & Caster Fork for Super, Senior or Junior Pickers
#71715	Small Swivel & Caster Fork for Single unit Picker
#71720	Large Front Wheel, Tubeless Tire and Axle for Super, Senior or Junior Picker
#71725	Small Front Wheel, Tire, Tube and Axle for Single Unit Picker and Outtrigger Bar
#71801	Pillow Block Bearings 3/4"
#71804	Tie Rods 3/8"
#71805	Axle 3/4"
#71806	Spacers
#71978	Wheel Only for Drum Section
#71809	Wheels and Tires Complete, Disc Shape 3/4" Axle Opening
#71810	Wittek Tire Picker End Wheel
#71811	Replacement Drums(less outside bearings) 3/4" Axle
#71818	Sure Catch Wire Hopper

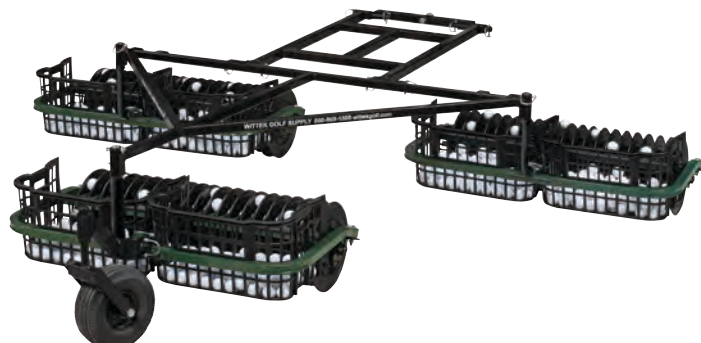

Check your order history @ www.wittekgolf.com

DISPENSERS & WASHERS



2002 To Current Signature Ball Dispenser

- #74126 Replacement Key #4657
- #74128 Replacement Key #7311
- #74223 Drop Coin Mechanism
- #74233 Bill Acceptor Only
- #74234 Actuator Arm
- #74241 Control Box
- #74242 Actuator Cable
- #74243 Accumulator Board



Wittek Elite Series Ball Dispenser

- #74759-1 Motor/Gearhead
- #74759-2 Plastic Block with Shafts
- #74759-3 Dispenser Shaft Assembly
- #74759-4 Ball Tray Assembly
- #74759-5 Bearings for 1" Shafts
- #74759-6 Dispenser Shaft Fingers
- #74759-7 Keypad Door Panel
- #74759-8 Timer Relay & Socket for Coin Mechanism
- #74759-9 Belt
- #74759-10 Rubber Door Bumper
- #74759-11 Bill Acceptor
- #74223 Drop Coin Mechanism
- #74128 Replacement Key #7311
- #74130 Replacement Key #



50G Junior

- #73173 1/4 H.P. Motor with Switch Coil
- #73174 1/4 H.P. Motor, No Switch
- #73175 Starter Switch with Heater Coil
- #73179 Vibrator Motor With Mounting Bracket
- #73186 Drive Coupling
- #73193 Wire Hopper
- #73571 Wheel for Dolly
- #73577 Washer Bearing Only
- #73578 Washer Bearing with Housing
- #73581 Quick Release Pin Only
- #73587 50G Jr. Rubber Strip Set
- #73651 50G Jr. Nylon Brush Drum
- #73655 Guide Set Only(no strips)

50G Superwash

#73179	Vibrator Motor With Mounting Bracket
#73178	Starter Switch with Heater Coil
#73186	Drive Coupling
#73193	Wire Hopper
#73373	1/2 H.P. Motor with Switch Coil
#73374	1/2 H.P. Motor, No Switch
#73566	50G Rubber Strip Set
#73571	Wheel for Dolly
#73577	Washer Bearing Only
#73578	Washer Bearing with Housing
#73580	Guide Set Only (No Strips)
#73581	Quick Release Pin Only
#73611	50G Brush Drum

**WASHERS****WITTEK TWIST**

#P28W10	Spiral
#P28W06	Bearings
#P28W09	Brush
#P28W04	LG Pulley
#P28W03	V-Belt
#P28W15	Belt Guard
#P28W05	Small Pulley
#P28W01	Motor
#P28WR01	Legs
#P28W08	Brush Shaft
#P28W11	Top
#P28W12	Grate
#P28W02	Switch
#P28W14	Cover
#P28W18	Wheel Kit

GO TO WITTEKGOLF.COM/MANUALS FOR MANUALS AND PRODUCT REPAIR GUIDES

TERMS & CONDITIONS**Satisfaction**

Your 100% satisfaction is our goal. Please notify us promptly should any product not meet your expectations.

Pricing

Prices are subject to change. On occasion, circumstances that are out of our control could result in price changes. Wittek Golf will always try to maintain and honor published pricing. All prices are F.O.B. shipping point.

Damage or Discrepancy

It is the customer's responsibility to notify carrier of any damage or discrepancy immediately. Once a bill of lading is signed the customer bears all liability for accuracy and quantity of all products. Any concealed damage must be reported to carrier immediately and to Wittek Golf within 5 business days.

Warranty

Items manufactured by Wittek Golf carry a one year warranty. Warranties on non-Wittek products vary by manufacturer. Associates are not authorized to give additional warranties without written permission.

Returns

No product may be returned without an approved Return Goods Authorization Number (RGA). RGA request must be made within 30 days of purchase. All returns must be unused and resellable. Credit cannot be issued for damaged or obsolete products. In most cases, Custom or Special Order products are not returnable. All returns are subject to a 15% restocking fee. Return freight charges may apply.

Credit Terms

Customers may receive commercial credit terms with approved credit applications. Full payment is expected on due dates. A service charge of 1.5% per month may be imposed on delinquent balances. Other forms of accepted payment include Visa, MasterCard, Amex, Discover, cashier's check, money order or wire transfer.

Chat with specialists @ www.wittek golf.com

Wittek Golf
300 Bond St.
Elk Grove Village, IL 60007
www.wittekgolf.com



Golf Supply Specialists

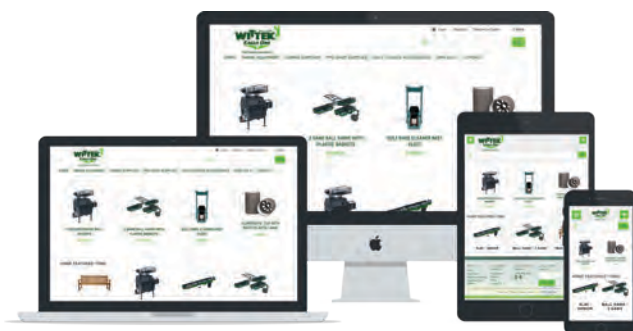

**Order Online at
wittekgolf.com**

300 Bond St.
Elk Grove Village, IL 60007
www.wittekgolf.com

Hours: 7:00am - 7:00pm CST
p: 800.869.1800 · f: 847.412.9591
wittekgolf.com · info@wittekgolf.com

4785 E. Bryson St.
Anaheim, CA 92807
www.wittekgolf.com